



*Intelligent
Solutions
for Broadcast.*

AMPLIFIERS

THESLA AMP5K / AMP6K

USER MANUAL
VOLUME 1



File Name: USER_MANUAL_THESLA_AMP5K_AMP6K_ING_1.0.cdr

Version: 1.0

Date: 15/08/2020

Revision History

Date	Version	Reason	Editor / Approval
15/08/2020	1.0	First Version	Carlos André

Tesla AMP5K / AMP6K - User Manual
Version 1.0

BIQUAD TECNOLOGIA LTDA.

Rua Marcos Flávio e Dias, 260 - Fernandes,
Santa Rita do Sapucaí / MG - Brazil CEP: 37540-000

Telephone: +55 35 3471-6399

Email: sales@biquadbroadcast.com

Web: www.biquadbroadcast.com

All rights reserved

Printed and bound in Brazil. No part of this manual may be reproduced, memorized or transmitted in any form or by any means, electronic or mechanic, including photocopying, recording or by any information storage and retrieval system, without written permission of the copyright owner.

Declaration of Conformity

Hereby, Biquad Broadcast, declares that this FM transmitter is in compliance with the essential requirements and other relevant provisions of Directive 2014/53/EU.



WARNING



The following information is needed in order to perform the change of output power.
 The non-respect of this content may cause damage to the equipment or to the people.
 Menus and images are for illustration purposes only and may differ from reality.

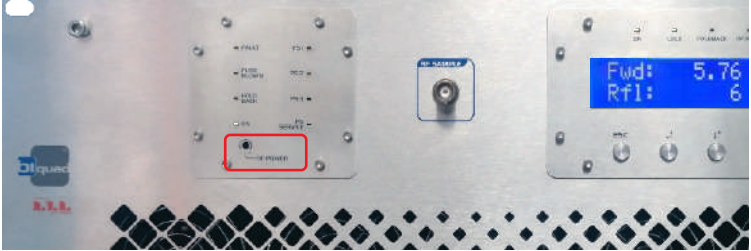
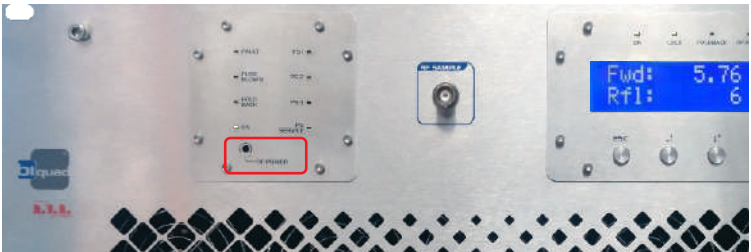

1. Startup procedure TX with Tesla AMP5K / AMP6K amplifiers

N	Operation	Result
1	Turn ON the exciter using the back panel switch	
2	Set the output power of the exciter to zero.	
3	Set the exciter frequency to the working value	
4	Turn on the amplifier.	
5	On amplifier rotate trimmer RF PWR ADJ completely counterclockwise to set the power to 0.	
6	Adjust the exciter output to have 50W at amplifier input. To check it press “ESC” key then select “Pwr” menu then press down arrow to visualize the measure. Note: The input power value read from the amplifier may differ from the one read from the modulator.	<pre> Fwd Pwr 0.00 kW Rfl Pwr 1.4 W SWR Off InP Pwr 50.0 W Int SWR Off W </pre>
7	Press “ESC” key until the display shows the main screen (FWD and RFL readings)	
8	Adjust output power using RF PWR ADJ trimmer.	
9	After ten minutes, readjust the output power of the amplifier(s), it will be lowered due to heating.	
10	Repeat the procedure if the carrier frequency is changed.	

This page was intentionally left blank

Technical Specification

Thesla AMP5K

Thesla AMP5K			
<i>Parameters</i>	<i>Conditions</i>	<i>U.M.</i>	
GENERAL S			
Frequency range		MHz	87.5 ÷ 108
Rated output power		W	5000
Spurious & harmonic suppression		dBc	< -75 (-80 typical)
Ambient working temperature		°C	0 to + 50 (operational -10)
POWER REQUIREMENTS			
Power supply type			monophase/biphase
AC Power Input	AC Supply Voltage	VAC	230 +10% -15% (*) 400 +10% -15% (**)
	AC Apparent Power Consumption	VA	7014
	Active Power Consumption	W	7000
	Overall efficiency	%	>70 (Typical 72)
	Power Factor		0,998
DC Power Input	Connector		ILME CQ 4/2
	DC Supply Voltage	VDC	//
	DC Current	mADC	//
MECHANICAL DIMENSIONS			
Phisical Dimensions	Front panel width	mm	483
	Front panel height	mm	177
	Overall depth	mm	720
	Chassis depth	mm	655
Weigh		kg	about 45
VARIOUS			
Cooling type			Forced with internal fans
Acoustic Noise		dBA	78
RF INPUT			
RF Input	Connector		N type
	Impedance	Ohm	50
Driver power for rated output		W	50 (70 Max.)
Max input power before protection		W	100
RF OUTPUTS			
RF Output	Connector		7/8" EIA
	Impedance	Ohm	50
RF Monitor	Connector		BNC
	Impedance	Ohm	50
	Output Level	dB	approx. -60
AUXILIARY CONNECTIONS			
Interlock Output	Connector		BNC
Com Bus	Connector		DB15M
I ² Cbus	Connector		DB9F
Telemetry Interface	Connector		DB25F
AUX power supply	Connector		//
FUSES			
On Mains			3 External fuses F20T 10x38 (Threephases 230V)
On services			//
On AUX Power supply			//
On P.A. Supply			8 Internal fuses F 25 A
On fans Supply			//
HUMAN INTERFACE			
Input device			4 pushbutton
Display			Alphanumerical LCD - 2 x 16

Technical Specification

Thesla AMP6K

			Thesla AMP6K
Parameters	Conditions	U.M.	
GENERALS			
Frequency range		MHz	87.5 ± 108
Rated output power		W	6000
Spurious & harmonic suppression		dBc	< -75 (-80 typical)
Ambient working temperature		°C	0 to + 50 (operational -10)
POWER REQUIREMENTS			
Power supply type			monophase/biphase
AC Power Input	AC Supply Voltage	VAC	230 +10% -15% (*) 400 +10% -15% (**)
	AC Apparent Power Consumption	VA	8650
	Active Power Consumption	W	8630
	Overall efficiency	%	>70 (Typical 72)
	Power Factor		0,998
DC Power Input	Connector		ILME CQ 4/2
	DC Supply Voltage	VDC	//
	DC Current	mADC	//
MECHANICAL DIMENSIONS			
Phisical Dimensions	Front panel width	mm	483
	Front panel height	mm	177
	Overall depth	mm	720
	Chassis depth	mm	655
Weigh		kg	about 45
VARIOUS			
Cooling type			Forced with internal fans
Acoustic Noise		dBA	78
RF INPUT			
RF Input	Connector		N type
	Impedance	Ohm	50
Driver power for rated output		W	50
Max input power before protection		W	100
RF OUTPUTS			
RF Output	Connector		7/8" EIA
	Impedance	Ohm	50
RF Monitor	Connector		BNC
	Impedance	Ohm	50
	Output Level	dB	approx. -60
AUXILIARY CONNECTIONS			
Interlock Output	Connector		BNC
Com Bus	Connector		DB15M
I ² Cbus	Connector		DB9F
Telemetry Interface	Connector		DB25F
AUX power supply	Connector		//
FUSES			
On Mains			3 External fuses F20T 10x38 (Threephases 230V)
On services			//
On AUX Power supply			//
On P.A. Supply			8 Internal fuses F 25 A
On fans Supply			//
HUMAN INTERFACE			
Input device			4 pushbutton
Display			Alphanumerical LCD - 2 x 16

Table of Contents

1. Preliminary Instructions	1
2. Warranty	1
3. First Aid	2
3.1 Treatment of electrical shocks	2
3.2 Treatment of electrical Burns	2
4. General Description	3
4.1 Unpacking	3
4.2 Features	3
4.3 Frontal Panel Description	5
4.4 Rear Panel Description	6
4.5 Connector Description	7
5. Quick guide for installation and use	9
5.1 Preparation	10
5.2 Operation	18
5.3 Management Firmware	19
5.4 Protection System	26
6. Identification and Access to the Modules	28
6.1 Upper View	28
6.2 Lower View	29
7. Working Principles	30
7.1 PS Section	31
7.2 RF Section	33
7.3 Logic Section	35
8. “Low-Drive Power” Option (/LD)	37
8.1 “Low-Drive power” Board	37
9. Maintenance and repair procedures	38
9.1 Introduction	38
9.2 Security Considerations	38
9.3 Ordinary maintenance	38
9.4 Module substitutions	39

IMPORTANT



The symbol of lightning inside a triangle placed on the product, evidences the operations for which is necessary gave it full attention to avoid risk of electric shocks.



The symbol of exclamation mark inside a triangle placed on the product, informs the user about the presence of instructions inside the manual that accompanies the equipment, important for the efficacy and the maintenance (repairs).

1. Preliminary Instructions

• **General Warnings**

This equipment should only be operated, installed and maintained by "trained" or "qualified" personnel who are familiar with risks involved in working on electric and electronic circuits. "Trained" means personnel who have technical knowledge of equipment operation and who are responsible for their own safety and that of other unqualified personnel placed under their supervision when working on the equipment. "Qualified" means personnel who are trained in and experienced with equipment operation and who are responsible for their own safety and that of other unqualified personnel placed under their supervision when working on the equipment.

⚡ WARNING: Residual voltage may be present inside the equipment even when the ON/OFF switch is set to Off. Before servicing the equipment, disconnect the power cord or switch off the main power panel and make sure the safety earth connection is connected. Some service situations may require inspecting the equipment with live circuits. Only trained and qualified personnel may work on the equipment live and shall be assisted by a trained person who shall keep ready to disconnect power supply at need.

Biquad Broadcast shall not be liable for injury to persons or damage to property resulting from improper use or operation by trained/untrained and qualified/unqualified persons.

⚡ WARNING: The equipment is not water resistant. Any water entering the enclosure might impair proper operation. To prevent the risk of electrical shock or fire, do not expose this equipment to rain, dripping or moisture.

Please observe local codes and fire prevention rules when installing and operating this equipment.

⚡ WARNING: This equipment contains exposed live parts involving an electrical shock hazard. Always disconnect power supply before removing any covers or other parts of the equipment.

Ventilation slits and holes are provided to ensure reliable operation and prevent overheating; do not obstruct or cover these slits. Do not obstruct the ventilation slits under any circumstances. The product must not be incorporated in a rack unless adequate ventilation is provided or the manufacturer's instructions are followed closely.

⚠ WARNING: This equipment can radiate radiofrequency energy and, if not installed in compliance with manual instructions and applicable regulations, may cause interference with radio communications.

⚠ WARNING: This equipment is fitted with earth connections both in the power cord and for the chassis. Make sure both are properly connected.

Operation of this equipment in a residential area may cause radio interference, in which case the user may be required to take adequate measures.

The specifications and data contained herein are provided for information only and are subject to changes without prior notice. **Biquad Broadcast** disclaims all warranties, express or implied. While **Biquad Broadcast** attempts to provide accurate information, it cannot accept responsibility or liability for any errors or inaccuracies in this manual, including the products and the software described herein. **Biquad Broadcast** reserves the right to make changes to equipment design and/or specifications and to this manual at any time without prior notice.

• **Notice concerning product intended purpose and use limitations.**

This product is a radio transmitter suitable for frequency-modulation audio radio broadcasting. Its operating frequencies are not harmonised in designated user countries. Before operating this equipment, user must obtain a licence to use radio spectrum from the competent authority in the designated user country. Operating frequency, transmitter power and other characteristics of the transmission system are subject to restrictions as specified in the licence.

2. Warranty

Biquad Broadcast warrants this product to be free from defects in workmanship and its proper operation subject to the limitations set forth in the supplied Terms and Conditions. Please read the Terms and Conditions carefully, as purchase of the product or acceptance of the order acknowledgement imply acceptance of the Terms and Conditions. For the latest updated terms and conditions, please visit our web site at [www.https://www.biquadbroadcast.com.br](https://www.biquadbroadcast.com.br). The web site may be modified, removed or updated for any reason whatsoever without prior notice. The warranty will become null and void in the event the product enclosure is opened, the product is physically damaged, is repaired by unauthorised persons or is used for purposes other than its intended use, as well as in the event of improper use, unauthorised changes or neglect. In the event a defect is found, follow this procedure:

- 1 Contact the seller or distributor who sold the equipment; provide a description of the problem or malfunction for the event a quick fix is available.

Sellers and Distributors can provide the necessary information to troubleshoot the most frequently encountered problems. Normally, Sellers and Distributors can offer a faster repair service than the Manufacturer would. Please note that Sellers can pinpoint problems due to wrong installation.

- 2 If your Seller cannot help you, contact **Biquad Broadcast** and describe the problem; if our staff deems it appropriate, you will receive an authorisation to return the equipment along with suitable instructions;
- 3 When you have received the authorisation, you may return the unit. Pack the unit carefully before shipment; use the original packaging whenever possible and seal the package perfectly. The customer bears all risks of loss (biquad shall not be liable for loss or damage) until the package reaches the Biquad factory. For this reason, we recommend insuring the goods for their full value. Returns must be sent on a C.I.F. basis (PREPAID) to the address stated on the authorisation as specified by the Biquad Service Manager.



Units returned without a return authorisation may be rejected and sent back to the sender.

- 4 Be sure to include a detailed report mentioning all problems you have found and copy of your original invoice (to show when the warranty period began) with the shipment.

Please send spare and warranty replacement parts orders to the address provided below. Make sure to specify equipment model and serial number, as well as part description and quantity.



BIQUAD TECNOLOGIA LTDA.
Rua Marcos Flávio e Dias, 260 - Jardim Beira Rio,
Santa Rita do Sapucaí / MG - Brazil CEP: 37540-000
Telephone: +55 35 3471-6399

3. First Aid

All personnel engaged in equipment installation, operation and maintenance must be familiar with first aid procedures and routines.

3.1 Electric shock treatment

3.1.1 If the victim is unconscious

Follow the first aid procedures outlined below.

- Lay the victim down on his/her back on a firm surface.
- the neck and tilt the head backwards to free the airway system (**Figure 1**).

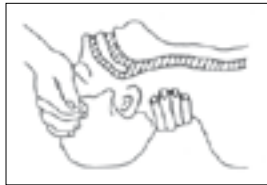

Figure 1

- If needed, open the victim's mouth and check for breathing.
- If there is no breathing, start artificial respiration without delay (**Figure 2**) as follows: tilt the head backwards, pinch the nostrils, seal your mouth around the victim's mouth and give four fast rescue breaths.



Figure 2

- Check for heartbeat (**Figure 3**); if there is no heartbeat, begin chest compressions immediately (**Figure 4**) placing your hands in the centre of the victim's chest (**Figure 5**).

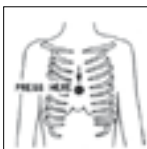

Figure 3

Figure 4

Figure 5

- One rescuer: give 2 quick rescue breaths after each 15 compressions.
- Two rescuers: one rescue breath after each 5 compressions.

- Do not stop chest compressions while giving artificial breathing.
- Call for medical help as soon as possible.

3.1.2 If the victim is conscious

- Cover victim with a blanket.
- Try to reassure the victim.
- Loosen the victim's clothing and have him/her lie down.
- Call for medical help as soon as possible.

3.2 Treatment of electric burns

3.2.1 Large burns and broken skin

- Cover affected area with a clean cloth or linen.
- Do not break any blisters that have formed; remove any clothing or fabric that is stuck to the skin; apply adequate ointment.
- Administer adequate treatment for the type of accident.
- Get the victim to a hospital as quickly as possible.
- Elevate arms and legs if injured.

If medical help is not available within an hour, the victim is conscious and is not retching, administer a solution of table salt and baking soda (one teaspoon of table salt to half teaspoon of baking soda every 250 ml of water).

Have the victim slowly drink half a glass of solution for four times during a period of 15 minutes.

Stop at the first sign of retching.

Do not administer alcoholic beverages.

3.2.2 Minor burns

- Apply cold (not ice cold) strips of gauze or dress wound with clean cloth.
- Do not break any blisters that have formed; remove any clothing or fabric that is stuck to the skin; apply adequate ointment.
- If needed, have the victim change into clean, dry clothing.
- Administer adequate treatment for the type of accident.
- Get the victim to a hospital as quickly as possible.
- Elevate arms and legs if injured.

4. General Description

The **Tesla AMP5K / AMP6K** is an **radio broadcasting amplifier** manufactured by **Biquad Broadcast** featuring adjustable RF power output up to 5000/6000 W under 50 Ohm standard load and less than 70 W drive power requirement.

The **Tesla AMP5K / AMP6K** is designed to being contained into a 19" rack box of 4HE.

4.1 Unpacking

The package contains:

- 1 **Tesla AMP5K / AMP6K**
- 1 User Quick Installation Manual
- 1 Mains power connector to be wired

The following accessories are also available from Your Biquad Dealer:

- Options for the machine: 8U Rack unit or 12U Rack Unit / Telemetry**
- Spare Parts**
- Cables**

4.2 Features

The overall efficiency of **Tesla AMP5K / AMP6K** is better than 75% across the bandwidth for this reason are part of **Biquad** family.

This performance characteristic is guaranteed in a range between +0.25 dB and -3 dB (+5% and -50%) referred to the nominal power of the equipment: for example from 3000W to 5300/6300W in case of **Tesla AMP5K / AMP6K**; outside these limits the equipment is able to work properly but can not guarantee an efficiency of 75%.

The operating logic during the output power regulation, which is necessary in order to not deteriorate the efficiency even of 5-6%, expects to set the pilot power to the optimum power (dependent on the amplifier: for example the **Tesla AMP5K / AMP6K** requires 50 W) and then successively adjust the bar setting of power on amplifier in order to obtain the desired output power.

The amplifier incorporates a low-pass filter to keep harmonics below the limits provided for by international standards (CCIR, FCC or ETSI).



Two major features of **Tesla AMP5K / AMP6K** are compact design and user-friendliness. Another key feature is its modular-concept design: the different functions are performed by modules with most connections achieved through male and female connectors or through flat cables terminated by connectors. This design facilitate maintenance and module replacement.

The RF power section of **Tesla AMP5K / AMP6K** uses eight LD-MOSFET (MRFE6VP61K25H) modules delivering up to 750W output power each.

An LCD on the front panel and a push-button panel provide for user interfacing with the microprocessor control system, which implements the following features:

- Output power setup.
- Power output enable/disable.
- User-selectable threshold settings for output power alarm (Power Good feature)
- Measurement and display of amplifier operating parameters.
- Communication with external devices such as programming or telemetry systems via RS232 serial interface or I²C.

Four LEDs on the front panel provide the following status indications: **ON**, **LOCAL FOLDBACK** and **RF MUTE**. On left side, four LEDs provide indications relatively the status of RF signal amplified: **FAULT**, **FUSE BLOWN**, **FOLDBACK** and **ON**. At last, on right side, four LEDs provide indications relatively the fault status of power supplies: **PS1**, **PS2**, **PS3** and **PS SERVICE**.

The amplifier management firmware is based on a menu system. User has four navigation buttons available to browse submenus: **ESC**, , , and **ENTER**.

The rear panel features the mains input connectors, RF power input connectors that allows its use with common mains voltages, telemetry connector, protection fuses, interlock input and interlock output connectors, I²C connector, SERVICE connector for programming and common bus connector for interfacing with other **Tesla AMP5K / AMP6K** in cascade.



IMPORTANT: *The equipment works in three-phase, with a star center connection, and can also be used in single-phase.*

4.3 Frontal Panel Description

4.3.1 Frontal Panel Description of Tesla AMP5K / AMP6K

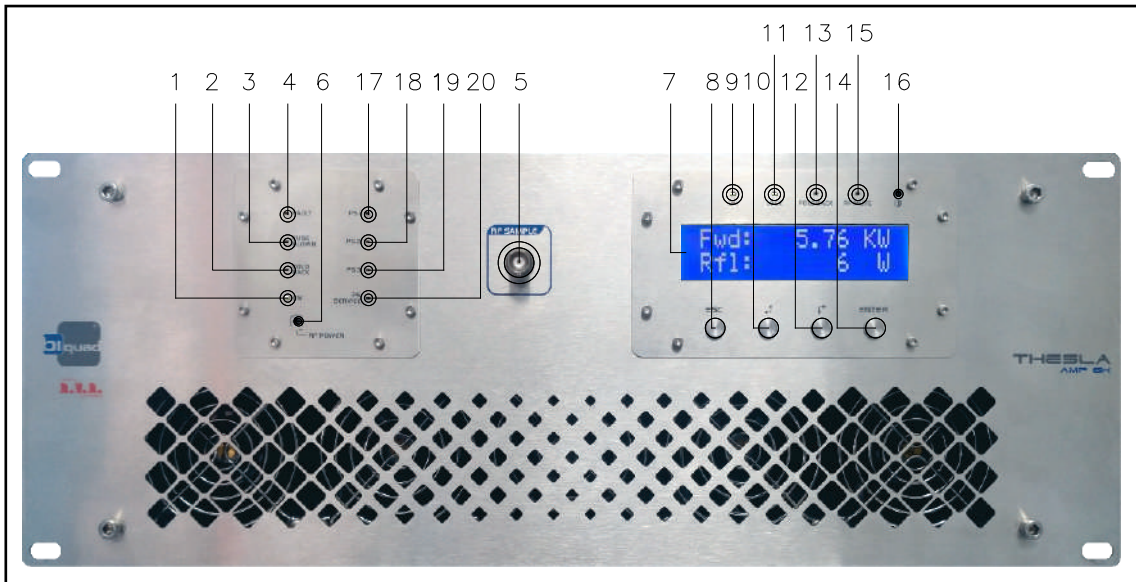

- | | |
|-----------------|---|
| [1] ON | Green LED, turns on when amplifier is switched on |
| [2] FOLDBACK | Yellow LED, indicating that the foldback function is active (automatic reduction of the distributed power) |
| [3] FUSE BLOWN | Yellow LED, that indicates the presence of one or more broken fuses |
| [4] FAULT | Red LED, lit on in presence of a fault that can not be resolved automatically |
| [5] RF TEST | BNC connector for RF monitor output. The output level is -60dB referred to the power output in 87.5 - 108 MHz range |
| [6] RF PWR ADJ | Power regulation trimmer |
| [7] DISPLAY | Liquid Crystal Display |
| [8] ESC | Press this button to exit a menu |
| [9] ON | Green LED, turns on when amplifier is powered on |
| [10] LEFT/UP | Navigation button used to browse menu system and edit parameters |
| [11] LOCAL | Yellow LED, indicating that the amplifier is in local control mode |
| [12] RIGHT/DOWN | Navigation button used to browse menu system and edit parameters |
| [13] FOLDBACK | Yellow LED, indicating that the foldback function is active (automatic reduction of the distributed power) |
| [14] ENTER | Press this button to confirm a modified parameter and open a menu |
| [15] RF MUTE | Yellow LED, lit on when the amplifier's power output is inhibited by an external interlock command |
| [16] CONTRAST | Trimmer to regulate the contrast of the LCD display |
| [17] PS1 | Red LED, lit on when the power supply does not supply due to a malfunctioning |
| [18] PS2 | Red LED, see point [17] |
| [19] PS3 | Red LED, see point [17] |
| [20] PS SERVICE | Red LED, lit on when one or more services power supplies does not supply due to a malfunctioning |

4.4 Rear Panel Description

4.4.1 Rear Panel Description of Tesla AMP5K / AMP6K



- | | |
|---------------------------|--|
| [1] TELEMETRY | DB25 connector for telemetry |
| [2] INTERLOCK IN | Interlock input BNC connector: to inhibit the amplifier from an external device, like a dummy load |
| [3] RF IN | RF input connector ("N" type) |
| [4] SERVICE | DB9 connector for factory parameters programming (only for factory programming) |
| [5] MAINS | Plug for mains power supply |
| [6] PS1 | Protection fuse of the power line 1 |
| [7] PS2 | Protection fuse of the power line 2 |
| [8] PS3 | Protection fuse of the power line 3 |
| [9] COMMON BUS | DB15 connector for interfacing with other devices |
| [10] INTERLOCK OUT | Interlock output BNC connector: to inhibit an external device, as an exciter. In case of fault, the inner connector is shorted to ground |
| [11] I ² C BUS | DB9 connector for I ² C bus networking |
| [12] RF OUT | RF output connector (7/8" EIA flange) |

4.5 Connector Description

4.5.1 Telemetry

Type: Female DB25

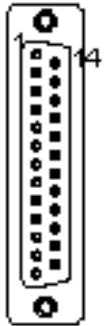

1	Internal SWR	4,3V x F.S.
2	RF power amplifier voltage	3.9V x 50V
3	GND	
4	Reflected Power	4.3V x F.S.
5	Interlock	
6	Set 4	
7	GND	
8	“On” Command	
9	Set 1	
10	WAIT	
11	Alarm Reset	
12	OFF	
13	Interlock	
14	Temperature	3.9V x 100°
15	RF power amplifier voltage Current	4.3V x F.S.
16	Forward Power	4.3V x F.S.
17	FAULT	
18	Set 3	
19	Potenza in ingresso	4.3V x F.S.
20	“OFF” Command	
21	GND	
22	Set 2	
23	LOC	
24	+Vcc	
25	ON	

4.5.2 I²C Connector

Type: Female DB9

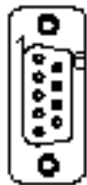

1	NC
2	SDA Serial Data
3	SCL Serial Clock
4	NC
5	GND
6	NC
7	NC
8	NC
9	NC

4.5.3 Common Bus

Type: Male DB15

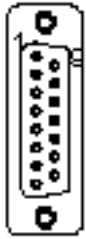

- | | |
|----|--------------|
| 1 | GND |
| 2 | RS 485- |
| 3 | ON-OFF C |
| 4 | IRQ C |
| 5 | PWR REG |
| 6 | NC |
| 7 | NC |
| 8 | NC |
| 9 | RS 485+ |
| 10 | GND |
| 11 | ST-BY C |
| 12 | GND |
| 13 | GND |
| 14 | INHIBIT PJ-C |
| 15 | RESET PJ-C |

4.5.4 Service (for programming of factory parameters)

Type: Female DB9

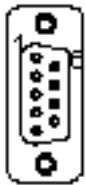

- | | |
|---|-----------------------------|
| 1 | NC |
| 2 | TX_D |
| 3 | RX_D |
| 4 | NC |
| 5 | GND |
| 6 | NC |
| 7 | Internally connected with 8 |
| 8 | Internally connected with 7 |
| 9 | NC |

5. Installation and use

This section provides a step-by-step description of equipment installation and configuration procedure. Follow these procedures closely upon first power-on and each time any change is made to general configuration, such as when a new transmission station is added or the equipment is replaced.



IMPORTANT: *always remove the mains voltage before carrying out any type of installation and/or maintenance. It is essential to interrupt the power supply to avoid the risk of electric shock which could cause material damage to people or property, serious injuries and even death.*

The equipment must only be installed by qualified personnel.

With qualified personnel, it identifies personnel who respond to all directives, laws and regulations concerning safety, applicable to installation and operation of this device.

The choice of qualified, and appropriately trained, personnel is always under responsibility of the company in which this personnel is a part, because is the company in question that determines whether a worker is suitable for a particular job, in order to protect its safety by respecting the applicable law on workplace safety matter.

These companies must provide appropriate training to their staff on electrical devices, and make sure that they familiarize themselves with the contents of this manual.

The respect of the safety instructions set, forth in this manual or in the specified legislation, does not exempt you from compliance with other specific regulations regarding installation, place, Country or other circumstances affecting the equipment.



IMPORTANT: *there is a possible danger due electric shock, therefore it is mandatory to comply with the applicable law on safety with regard to electrical aspects.*

Once the desired configuration has been set up, no more settings are required for normal operation; at each power-up (even after an accidental shutdown), the equipment defaults to the parameters set during the initial configuration procedure.

The topics covered in this section are discussed at greater length in the next sections, with detailed descriptions of all hardware and firmware features and capabilities. Please see the relevant sections for additional detail.



IMPORTANT: *When configuring and testing the transmitter in which the equipment is integrated, be sure to have the Final Test Table supplied with the equipment ready at hand throughout the whole procedure; the Final Test Table lists all operating parameters as set and tested at the factory.*

5.1 Installation

5.1.1 Preliminary Requirements

The equipment ventilation and the work space must be suitable for maintenance operations according to the directive in force in the country in which this device is installed.

It is necessary to leave a minimum distance of 50 cm on the front and back sides of the device to have a proper functioning and to facilitate air circulation through the ventilation grids.

In any case, the device must respect the distance established by the safety directive in force in the country where this equipment is installed.

This device is designed to operate at -10 °C to 45 °C without loss of performance. The ambient air must be clean of dust and not condensed; the maximum humidity must never exceed 95%.

It is important to remember that strong changes in temperature can lead to generation of condensation, in particular environmental conditions. In case of the station where this device is located should be subjected to these physical events, it is good to monitor these devices, once you put it into service, in addition to trying to protect the device itself as much as possible.



IMPORTANT: *never supply voltage to the equipment in presence of condensation. This problem can occur more frequently in devices warehoused for a long time or in those used as an active reserve.*

The antenna RF, power supply and connection cables must have the section suitable for the maximum current intensity.

5.1.2 Preliminary checks

Unpack the transmitter and immediately inspect it for transport damage. Check carefully that all the connectors are in perfect condition and check for the absence of humidity. Otherwise, wait until it is completely dry.

In case of problems in this step, immediately contact after-sales assistance.

The mains power supply protection fuses are conveniently located externally on rear panel. Remove the fuse holder with a screwdriver to check its integrity or to replace it if necessary. The following fuse are used:

Tesla AMP5K / AMP6K	
Mains fuses 1-2-3	(3x) 25A-T type 10x38

Table 5.1: Fuses

5.1.2 Placement of equipment

Useful tips for a correct installation:

- Do not use in presence of external elements near inlets and outlets ventilation systems, as they could prevent a proper ventilation of the device.
- Do not place near any source of heat or flammable gas.
- Avoid places subject to accumulation of humidity, dust, sand, salt or environments that could compromise the correct operation of the equipment.
- Avoid installing the equipment into inhabited places due to possible noise pollution or on fragile supports. The operation of the equipment can cause a noise due to forced ventilation. The mounting surface must be able to withstand the weight of the device and must be sturdy.



Note: below we will refer to a complete station, where the device can be a part of it. The same procedures also apply in case of the device is used individually.

The device is usually connected inside a 19 “rack and fixed with M5 screws in the appropriate holes.

The equipment must be installed at least 1 mt from the ground.

Install the rack in the point in which the transmitter will be put in operation. The rack is mounted on wheels for easy movement so that, once placed in the desired location, it is advisable to use the four screws located at the base of the rack to stabilize it perpendicularly to ground.

The environment, where you have decided to install the rack, should be set up for about 25°C of air conditioning and equipped with a filter to remove dust and salt air.



The transmitter normally have the outlet air in the back of machine. In this case, provide adequate ventilation of the room.

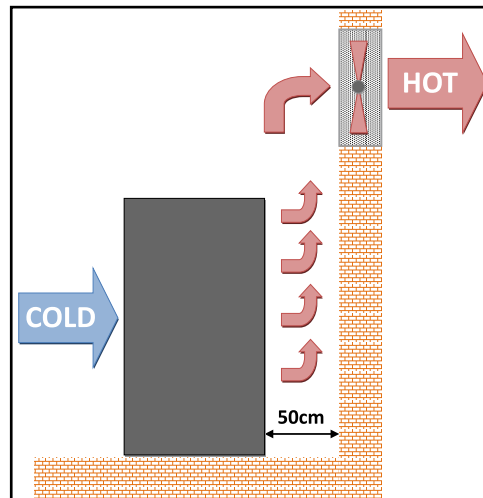

In alternative is cooled by forced ventilation and the air outlet is located on the roof of machine. Is recommended a length of tube approximetively of 1,5 meter.

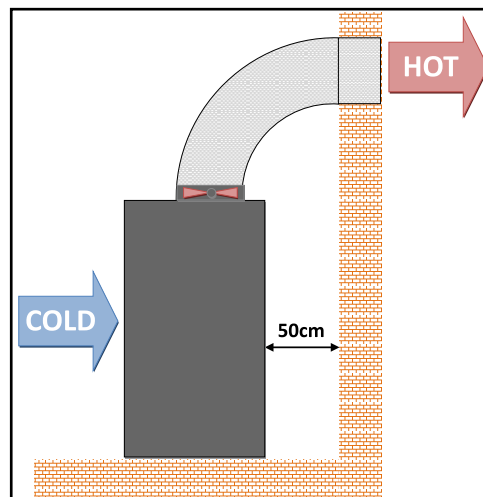

Is highly recommended to install the rack at least 50 cm from the rear and side wall so as to allow an optimum air flow and to facilitate workers.

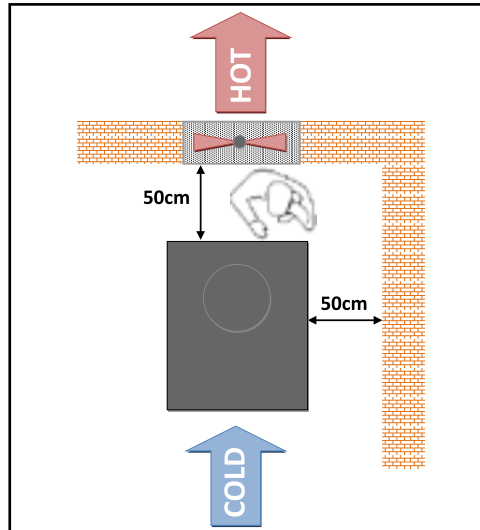

5.1.2.1 Rack power supply connections

Provide for the following (applicable to operating tests and putting into service):

- √Mains power supply 230 VAC or 400 VAC for **Tesla AMP5K / AMP6K**, both with adequate earth connection.
- √For operating tests only: dummy load with 50 Ohm impedance and adequate capacity (6000W as a minimum for **Tesla AMP5K / AMP6K**).

Connect the overall power cord of machine. The cable can be slid through the cable gland located on the back, or on the roof, of the machine and conductors must be attached to the general disconnecting switch terminals.



Note: The connection of machine to power supply is done by fixing a multi-pole cable with exposed terminals to a terminal board. Make sure, with no possibility of error, that the cable is not under tension when you connect it to the machine.



WARNING: Is highly recommended to don't turn on the machine without first having connected the RF output to antenna or dummy load!

If you have a dummy load capable to dissipate the RF power generated by the transmitter, it is advisable to carry out first tests by linking to it rather than to the transmission antenna.

If transmitter require a single-phase power with F (black or brown or grey) + N (blue) + GND (green yellow), keep in mind this requirement to connect to your distribution board.

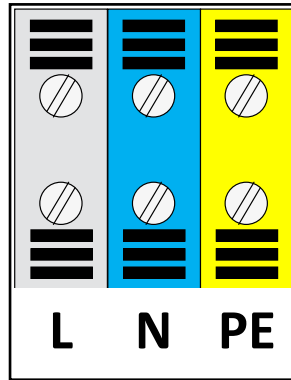

If transmitter require three-phase power with 3F (black, brown and grey) + N (blue) + GND (green yellow), keep in mind this requirement to connect to your distribution board.

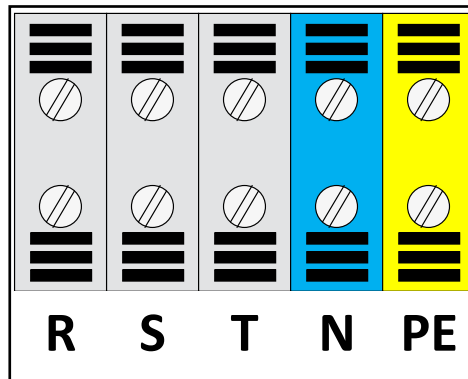

Note: the mains must be equipped with adequate earth connection properly connected to the equipment. This is a pre-requisite for ensuring operator safety and correct operation.

The following table shows the recommended cable cross-sections:

CONNECTOR	THREE-PHASE CABLE SECTION	SINGLE-PHASE CABLE SECTION
L	/	Ø 6mm
R	Ø 4mm	/
S	Ø 4mm	/
T	Ø 4mm	/
N	Ø 4mm	Ø 6mm
PE	Ø 4mm	Ø 6mm

Typically the distribution board contains the thermal-magnetic circuit breakers for each amplifier included in the system and one for service.

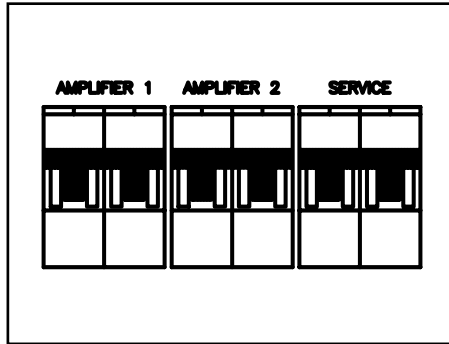

WARNING: Electric shock hazard! Never handle the RF output connector when the equipment is powered on and no load is connected. Injury or death may result.

Ensure that the distribution board of the transmitter is set to “OFF”.

5.1.3 Device power supply connections

Provide for the following (applicable to operating tests and putting into service):

- √ Single phase mains power supply (P+N) 230 VAC (-15% / +10%) or three phase mains power supply (3P+N) 400 VAC (-15% / +10%) , both with adequate earth connection.
- √ FM exciter with adjustable output power up to 50W (minimum) .
- √ For operating tests only: dummy load with 50 Ohm impedance and adequate capacity (6000W as a minimum).



Note: to ensure the safety of the operators, carry out the wiring according to the laws and regulations in force in the country where this equipment is installed.

Check that the **POWER** switch on the back of **Thesla AMP5K / AMP6K** is in the “OFF” position.

An **ILME** model **KKCNTCQF04/2 (CQF04/2)** multipole socket is supplied with the amplifier to power the machine. The socket must be connected to the multipole cable that will be wired to the mains switchboard.



WARNING: to avoid any risk of shock make absolutely sure that the power supply cable is **NOT** powered when the multipole socket is connected to the cable itself.

Connect the multipole socket to the power supply cable as described below and refer to figure 5.1:

Three-phase power supply:

- G Ground
- 1 R Phase
- 2 S Phase
- 3 T Phase
- 4 Neutral
- 11,12 Not connected

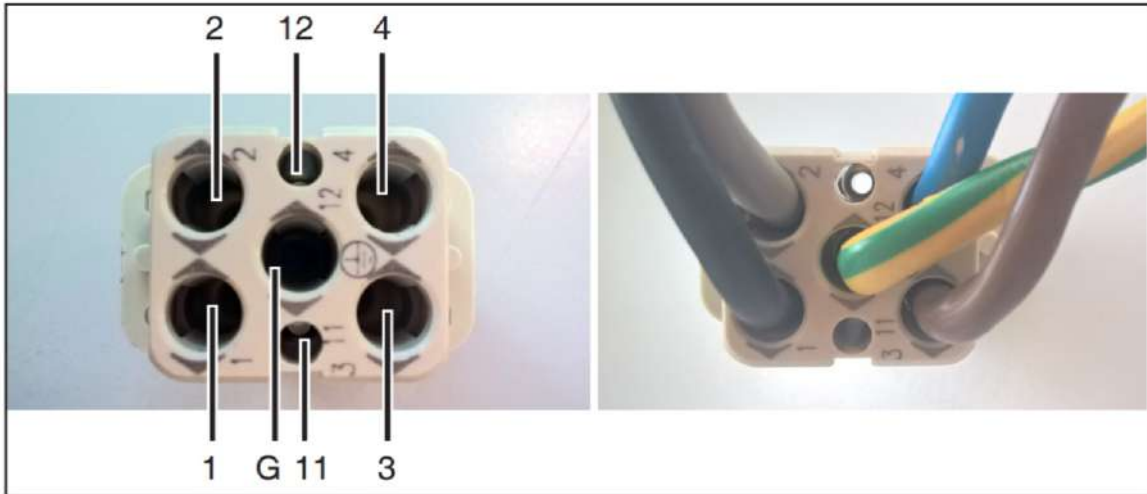

Figure 5.1: View of the mains multipole socket - terminals side (internal)

Connect the mains cable to the appropriate MAINS VOLTAGE terminal block on the rear panel.



Warning: Be sure to connect the equipment correctly, to **avoid the risk of damaging**. It is necessary connect the ground conductor of the power supply cable to the specific terminal in the multipole socket and check the efficiency of your own grounding system.

The control and RF connection diagram, between the amplifier and its exciter, and the connection with the load are represented in figure 5.2.



Note: to ensure both the safety of the operators and the correct functioning of the apparatus, it is essential that the network system is grounded, and that it is properly connected to the equipment.

Useful tips for a correct connection:

- Provide an adequate grounding of the electrical system. This has both a direct protection function, as it prevents receiving shocks by touching directly the metallic enclosures of the equipments, as well as an indirect protection function, as it interrupts the energy supply when a leak occurs due to poor insulation. This is possible on its own even through discharge devices, like the installation of a picket and an inspectable cockpit, through specific companies with qualified personnel to carry out the work.

- Provide an internal lightning protection such as a surge arrester (internal SPD) or a thermal-magnetic circuit breaker, requiring the installation in the distribution panel through qualified personnel. This solution allows you to protect from violent atmospheric electric shocks that strike the surrounding ground up to several kilometers.
- Provide an internal protection against interference on the distribution line such as EMI filters or stabilizers on line voltages, requiring the installation in the distribution panel through qualified personnel, which allow to filter the interferences caused by electrical equipment and sudden surges of the line, in addition to providing a voltage regulation.

5.1.4 RF Connections

Provide for the following setup (applicable to operating tests and putting into service):

√ Connection cable kit including:

- Mains power cable.
- Coaxial cable with BNC connectors for interlock signal connection between exciter and amplifier.
- RF cable for output to load / antenna (50 Ohm coaxial cable with standard N connector).
- Audio cables between transmitter and audio signals sources.



WARNING: risk of burns due to RF. Make sure that the device can not emit RF at the output, before connecting the antenna cable.



WARNING: For electromagnetic compatibility reasons, only double shielded cables must be used on the RF output.

Don't forget to equip yourself with a 7/8" 50 Ohm RF cable for the connection between the Antenna and the device; the part that goes towards the device must be equipped with a 7/8" type connector.

Connect the RF output of the transmitter to an antenna cable or to a dummy load capable of dissipating the power generated by the amplifier. To begin with, set exciter to minimum output power and switch it off.

Connect the amplifier INTERLOCK OUT output to the matching INTERLOCK IN input fitted on all Biquad Broadcast exciters as standard; if your exciter is a different brand, identify an equivalent input.

Connect the RF output to an adequately rated dummy load or to the antenna.

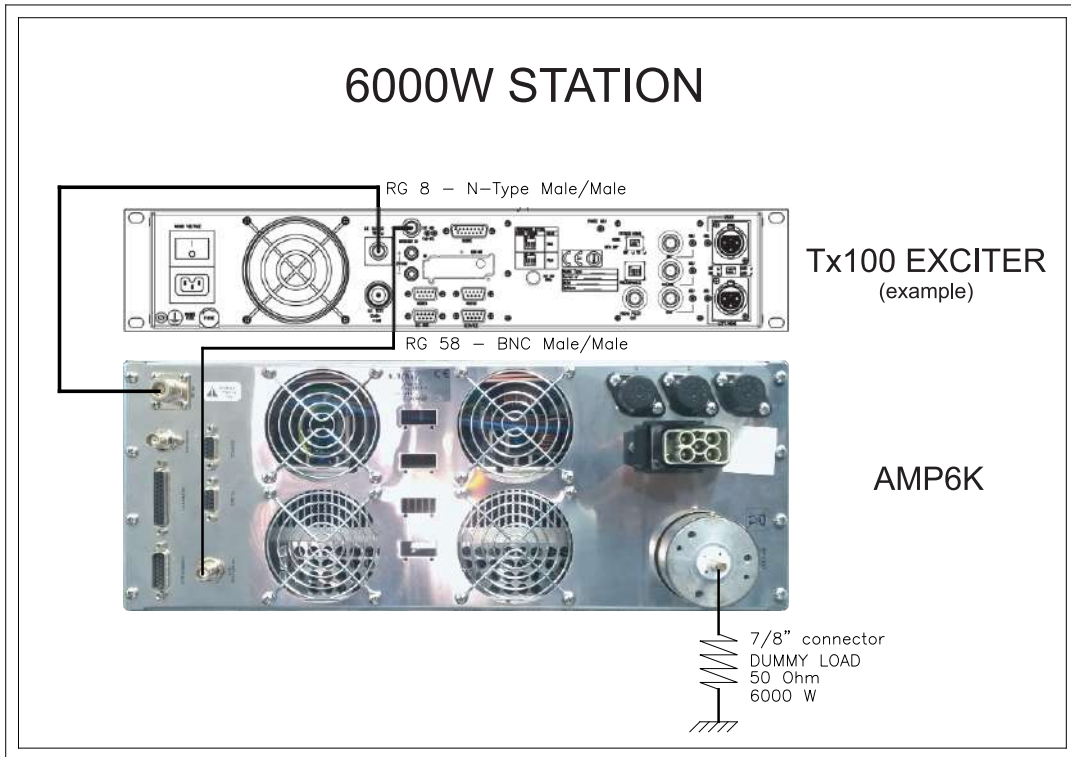

Figure 5.2: **Connections with exciter**



WARNING: To avoid electrical shock and electrocution, never touch the RF output connector when the equipment is switched on and no dummy load is connected.

Connect the audio and RDS/SCA cables of own sources to the input connectors.

5.2 Operation

- 1) After having plugged in the power supply socket at the back of the machine, power on the amplifier via the switchboard. The **ON** LEDs will turn on and the forced cooling blowers will start running. The LCD shows the first introductory screenful and then switches to a screenful that indicates the forward and reflected power values.

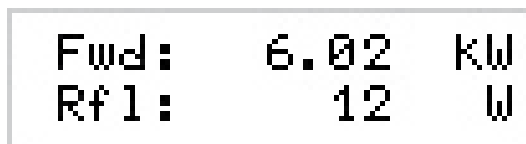

Menu 1

- 2) Rotate trimmer **RF PWR ADJ** completely counterclockwise to set the power to 0.
- 3) Adjust the exciter output, to which this amplifier is connected, to have 50W at amplifier input.

- 4) Adjust output power using **RF PWR ADJ** trimmer.
- 5) At this point, the amplifier is adjusted to its nominal power.



Note: After ten minutes, readjust the output power of the amplifier(s), it will be lowered due to heating. **Repeat the procedure if the carrier frequency is changed.**



Note: the amplifier **does not have AGC function**, but only have security features.



WARNING: Machine is capable of delivering more than rated output power (6000 W); however, never exceed the specified power rating.



NOTE: Exciter drive power setting should never exceed 50W, or it will trigger an Overdrive Alarm.

Next, you can review all operating parameters of the machine through the management firmware.

Normally, the machine can run unattended. Any alarm condition is handled automatically by the safety system or is signalled by the LED indicators on the panel or by display messages.



NOTE: Standard factory settings are: output power set to upper limit (unless otherwise specified by customer) and **OFF**.

5.3 Management Firmware

The machine features an LCD with two lines by 16 characters that displays a set of menus. Figure 5.2 below provides an overview of machine menus.

The symbols listed below appear in the left portion of the display as appropriate:

- (Cursor) - Highlights selected (i.e. accessible) menu.
- ▶ (Filled arrow) - Editable parameter marker. This symbol appears in menus that take up more than two lines to aid browsing.
- ▶▶▶ (Three empty arrows) - Parameter is being edited.
- ▶ (Empty arrow) - Current line marker; the parameter in this line cannot be edited. This symbol appears in menus that take up more than two lines to aid browsing.

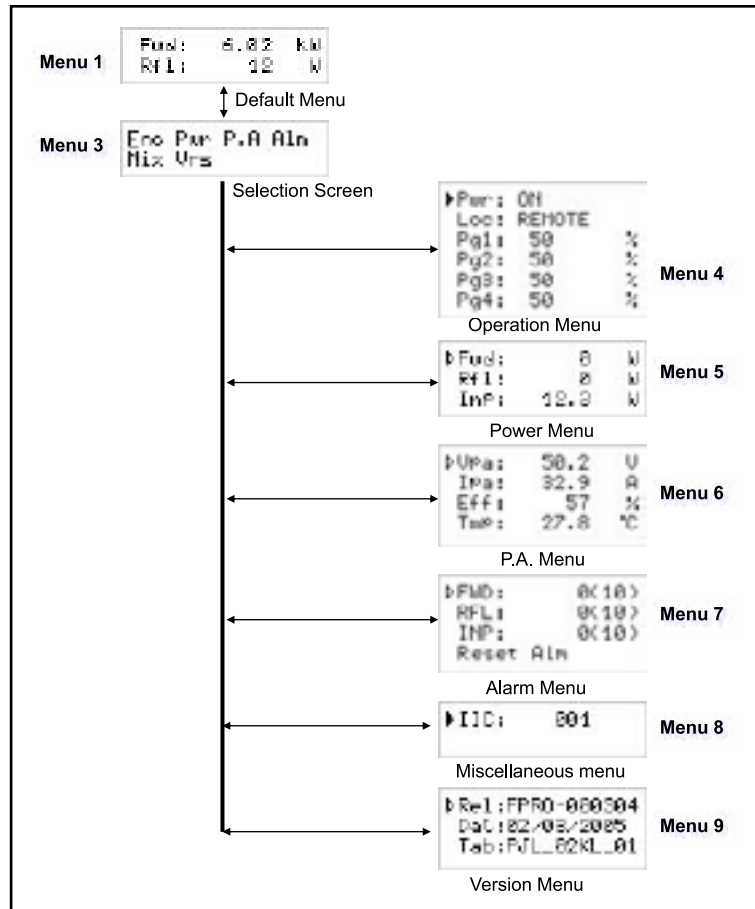
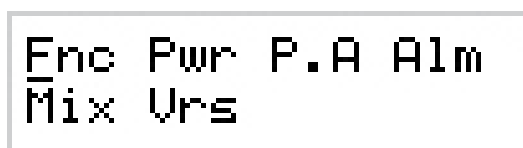

Figure 5.2

When the display is off, touching any key will turn on backlighting.

When the display is on, pressing the **ESC** button from the **default menu** (menu 1) calls up the **selection screen** (menu 3), which gives access to all other menus:



Menu 3

To gain access to a submenu, select menu name (name is highlighted by cursor) using button $\downarrow \rightarrow$ or $\leftarrow \uparrow$ and press the **ENTER** button.

Press **ESC** again to return to the **default menu** (menu 1).

5.3.1 Operation Menu (Fnc)

In this menu, you can set **power output** On/Off, toggle between “Local” or “Remote” control mode and set the **Forward Power Good (PGD)** threshold rate.

To edit an item, highlight the appropriate line using the UP and DOWN buttons and then press and hold the **ENTER** button until the command is accepted. This way, Pwr setting is toggled between On and Off and Mod setting is toggled between “x1” and “x10”. To edit the Power Good rate, simply select item “PgD” and edit its value using buttons $\leftarrow \uparrow$ and $\downarrow \rightarrow$; finally, press **ENTER** to confirm.

```

▶Pwr : ON
  Loc : REMOTE
  Pg1 : 50      %
  Pg2 : 50      %
  Pg3 : 50      %
  Pg4 : 50      %
    
```

Menu 4

- Pwr Enables (ON) or disables (OFF) amplifier power output.
- Loc Modifies machine operation. In the LOCAL mode, the machine can read and modify its operating parameters through the navigation keys and the management firmware, whereas all other sources are locked out. In the REMOTE mode, the machine can only read its operating parameters; parameters are modified based on the commands received from other connected telemetry systems.
- Pg1 Modifies Power Good (forward power) threshold. The Power Good rate is a percent of machine rated power (6000W for **AMP6K**), not of forward output power. This means that this threshold set at 50% will give 3000 W regardless of set power level. The Power Good feature enables output power control and reporting. When output power drops below set Power Good threshold, the equipment changes the state of pin [9] of the DB25 “Remote” connector located on the rear panel.
- Pg2 Like Pg1, modifies a second Power Good threshold for forward power. When output power drops below set Power Good threshold, the equipment changes the state of pin [22] of the DB25 “Remote” connector located on the rear panel.
- Pg3 Like Pg1, modifies Power Good threshold for reflected power. When output power drops below set Power Good threshold, the equipment changes the state of pin [18] of the DB25 “Remote” connector located on the rear panel.
- Pg4 Like Pg1, modifies a second Power Good threshold for reflected power.

5.3.2 Power Menu (Pwr)

This screen holds all readings related to machine output power:

↳ Fwd:	0	W
Rfl:	0	W
InP:	12.3	W

Menu 5



Note that these are readings, rather than settings, and cannot be edited (note the empty arrow). To change power setting, go to the **default menu** (menu 1) as outlined earlier.

Fwd Forward power reading.

Rfl Reflected power reading.

Inp Input power reading.

5.3.3 Power Amplifier Menu (P.A)

This screen is made up of four lines that can be scrolled using the buttons  and , shows the readings relating to final power stage:

↳ Vpa:	50.2	V
IPa:	32.9	A
Eff:	57	%
Tmp:	27.8	°C

Menu 6

Note that these are readings, rather than settings, and cannot be edited (note the empty arrow).

VPA Voltage supplied to amplifier module.

IPA Current absorbed to amplifier module.

Eff Efficiency based on ratio of forward power to amplifier module power in percent (FWD PWR/(Vpa x Ipa) %).

Tmp Machine internal temperature.

5.3.4 Alarm Menu (Alm)

This menu shows any alarm conditions occurring during machine operation. Alarm thresholds are preset at the factory.

```

▶FWD:      0(10)
RFL:      0(10)
INP:      0(10)
Reset Alm
```

Menu 7

- FWD Counter of alarm conditions triggered by forward power.
- RFL Counter of alarm conditions triggered by reflected power.
- INP Counter of alarm conditions triggered by input power.
- Reset Alm Alarm counter reset.

Alarm conditions are numbered from 1 to 10 and reflect the following situations: forward output power too high, reflected output power too high and input power too high.

Alarm monitoring cycle is as follows: when an alarm condition is detected, alarm counter increases by 1 unit, machine goes into lock-out state and the display shows the cause for the stop. After 15 seconds, the machine attempts to re-start; if a new alarm condition is detected, cycle is repeated over and over again up to 10 times maximum.

If machine re-starts successfully, all alarm counters are reset after 30 minutes' regular operation. After 10 alarm conditions triggered by the same cause, the machine goes into fault lock-out mode, a lock-out mode warning appears on the display and the "FAULT/LOCK" LED turns on.

After the alarm condition has been rectified, the counter can be reset by highlighting "Reset Alm" and holding down the **ENTER** key for some time.

5.3.4.1 Alarms and Faults

There are three types of alarms that can cause a machine lock-out and trigger a "FAULT/LOCK" indication. **When any one of the three alarm thresholds is exceeded, the system will automatically switch to the warning screen (even though the user is browsing system menus) and the following messages are displayed:**

1. Over Forward Power

Forward power threshold exceeded.

```
!! ATTENTION !!
OVER FWD Power
```

Alarm 1

2. Over Reflected Power

Reflected power threshold exceeded.

```
!! ATTENTION !!
OVER RFL Power
```

Alarm 2

3. Over Input Power

Input power threshold exceeded.

```
!! ATTENTION !!
OVER INP Power
```

Alarm 3

Monitoring cycle is as follows:

- An alarm condition occurs;
- Alarm is displayed and device is locked out for 15 sec.;
- Operating conditions are restored;
- Verification.

Upon reaching the 10 cycle limit, a “FAULT/LOCK” indication is triggered and the device goes into lock-out mode; the appropriate LED turns on (figure 6.1) and this screen is displayed:

I. Over Forward Power

Forward power alarm display.

```
!! HALTED FOR !!
OVER FWD Power
```

Stop 1

II. Over Reflected Power

Reflected power alarm display.

```
!! HALTED FOR !!
OVER RFL Power
```

Stop 2

III. Over Input Power

Input power alarm display.

```
!! HALTED FOR !!
OVER INP Power
```

Stop 3

Once the machine goes into “FAULT” mode, it will no longer attempt to re-start; choose the appropriate reset procedure according to current machine setting:

- Machine set to LOCAL control mode - press “Reset Alm” in the alarm menu (menu 7) or power off and back on again using the **POWER** switch.
- Machine set to REMOTE control mode - power off and back on again sending the appropriate command via the DB25 connector (pin [8] and [20]).

There is a fourth alarm that does not trigger a “FAULT” condition, but allows some time until correct operating conditions are restored. When the temperature alarm threshold is exceed (about 85°C), the following screen appears:

4. Over Temperature

Temperature power threshold exceeded.

```
!! ATTENTION !!
OVER TEMPERATURE
```

Alarm 4

5.3.5 Miscellaneous Menu (Mix)

This screen holds machine version/release information:

```
► IIC: 001
```

Menu 8

IIC I²C address setting. The I²C network address becomes significant when the exciter is connected in an Biquad transmission system that uses this protocol. Do not change it unless strictly required.

5.3.6 Version Menu (Vrs)

This screen holds machine version/release information:

```

↳Rel:FPRO-000304
  Dat:02/03/2005
  Tab:PJL_02KL_01
  
```

Menu 9

Note that these are readings, rather than settings, and cannot be edited (note the empty arrow).

- Rel Firmware release information.
- Dat Release date.
- Tab Shows table loaded in the memory.

5.4 Protection System

The protection system implemented inside the amplifier is based on two types of intervention.

The first reaction is called “Foldback” and consists in decreasing the voltage in the power amplifier when the forward or reflected power exceeds the proportional limit voltage value. As such, the amplifier’s gain is reduced and the overall result is an action that opposes the increase of the forward or reflected power. The yellow LED on the front panel indicates the tripping of the foldback circuit.

The second type of reaction consists in turning OFF the equipment’s amplifying section when a specific variable exceeds a set value.

Depending on the type of event that has occurred, after that the amplifier has been turned off, it will be reactivated after a fixed time interval or only after that the sharing which caused the block has been removed.

When the protection system trips due to a “cyclic” type parameter, a counter begins counting up (the X value in the alarm menu). If the counter reaches the max admissible cycle value (Y), the amplifier turns OFF definitely and the red “FAULT” LED lights up on the front panel.

The user may press the ALARMS RESET key, in alarms menu, to interact with the protection system.

If the system is transmitting but alarms were triggered earlier causing certain counters not to be at “0”, will have no effect unless it is pressed while inside the alarm menu. As such, the system will be sure that the user takes note of the alarms that were triggered before resetting them.

The system resets the alarm counters automatically after thirty minutes of operation, i.e. the user need not do anything, if the amplifier does not trigger any alarms or after the machine the machine has been turned OFF and then back ON.

5.4.1 Auxiliary Protection

The amplifier contains a second microcontroller that manages local measurements and carries out auxiliary protection functions of the machine together with the main protection system. This microcontroller card indicates its interventions via LED

A delivered power automatic back-off mechanism is envisaged for excess temperature, SWR or current absorbed by a MOSFET module. The yellow FOLDBACK LED indicates this case.

A FAULT signal is triggered (red LED) when a fault occurs that stops the power amplifier. This situation is signaled to the machine’s main microcontroller as well and triggers a lock situation (FAULT).

The LED FUSE BLOWN indicates that one of the fuses that protects the power supply of the MOSFET modules has blown. In this case the machine keeps running as usual (obviously without the contribution of the module) even if it is advisable to single out and clear the cause for the malfunction and replace the fuse as soon as possible to fully restore the machine’s working efficiency.

5.4.2 Power Supply Units

Three power supply units, which work in parallel mode, power the machine. Should one of the power supply units malfunction, the machine automatically compensates the delivered power down to a value compatible with the current deliverable from the surviving power supply. This situation is indicated by the “PS” LEDs on the front panel.

6. Identification and Access to the Modules

The **Tesla AMP5K / AMP6K** is made up of various modules linked to each other through connectors so as to make maintenance and any required module replacement easier.

6.1 Upper view

The figure below shows the upper view of the machine with the various components pointed out.

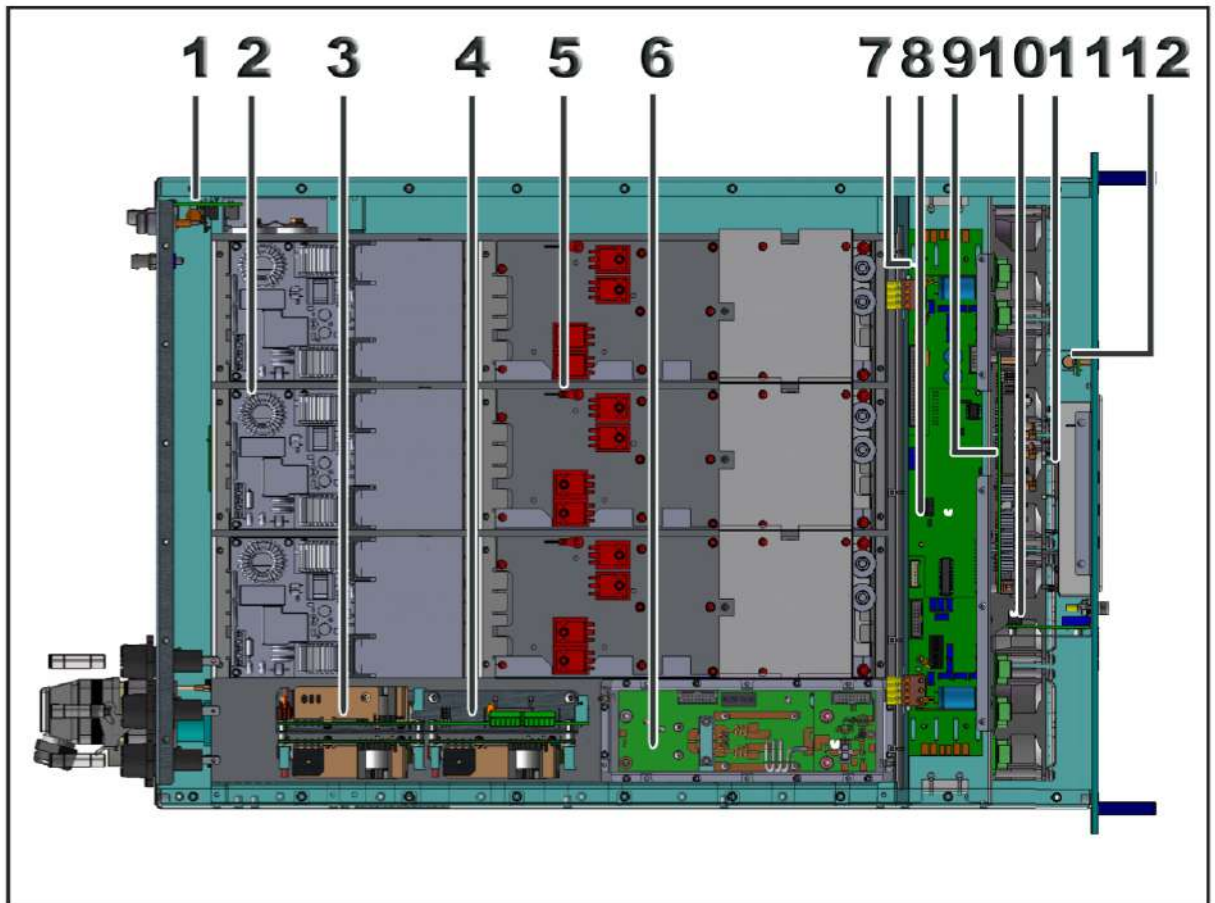

figure 6.1

- [1] Telemetry
- [2] PFC
- [3] Services Power Supplies
- [4] Blower Control Board
- [5] Power Supplies
- [6] PWR Input Measure Card
- [7] Bias e Measure Card
- [8] CPU Card
- [9] Signal Interface Card
- [10] Status Led Card
- [11] Panel Card
- [12] PS Fault LED Card

6.2 Lower view

The figure below shows the lower view of the machine with the various components pointed out.

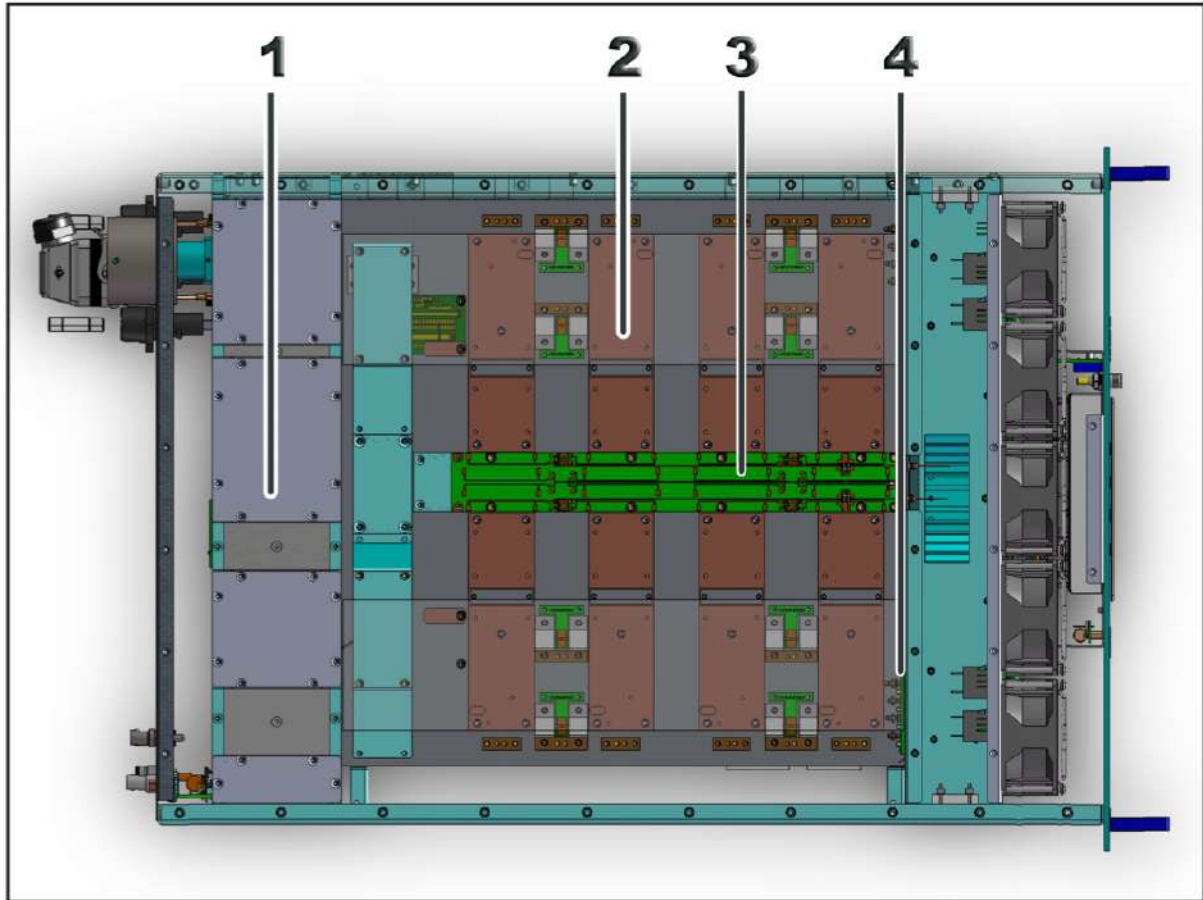

figure 6.2

- [1] Low Pass Filter and Combiner
- [2] Amplifier Modules
- [3] Bias Distributor and Splitter Card
- [4] Pass-through Filter Card

7. Working Principles

The figures below provide an overview of **Tesla AMP5K / AMP6K** (figure 7.1) modules and connections.

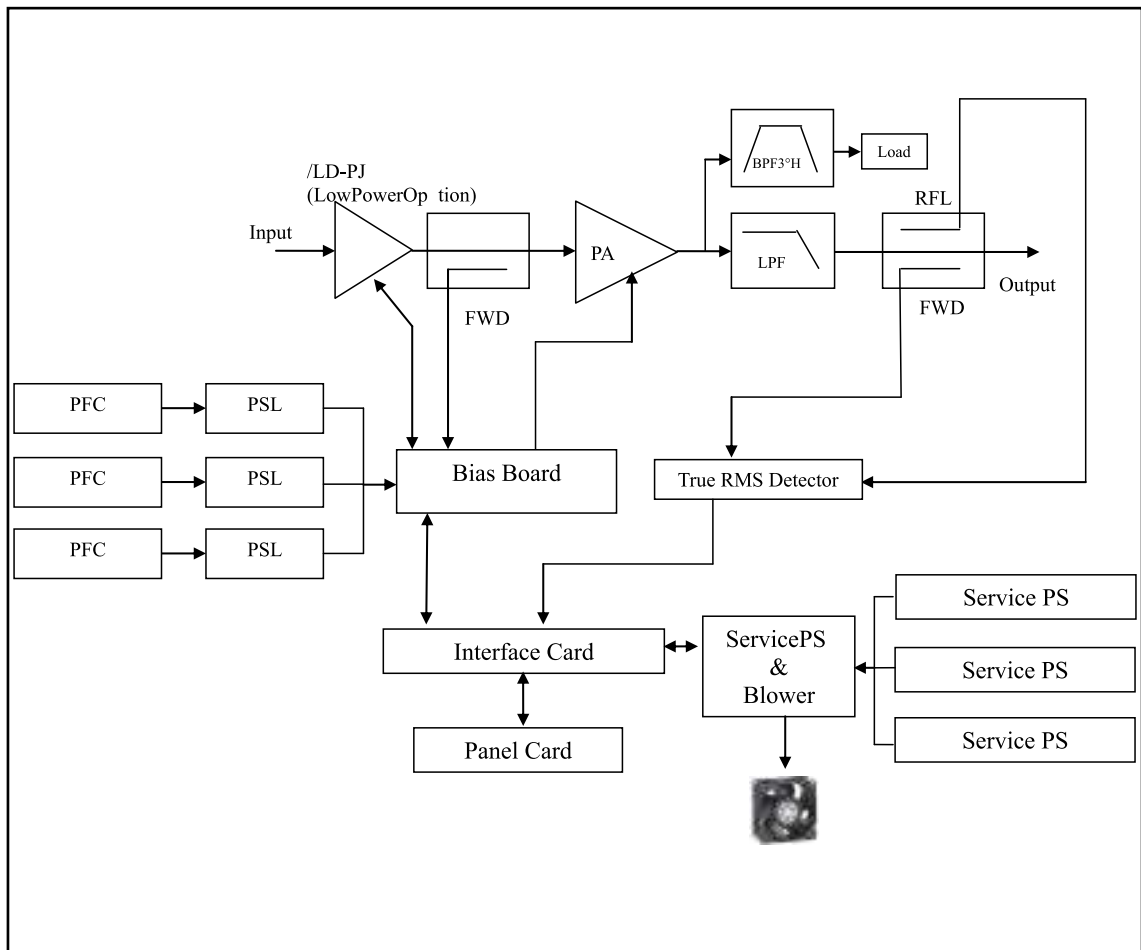

figure 7.1

7.1 PS Section

The figures below provide a schematic view of PS section of **Thesla AMP5K / AMP6K** (figure 7.2) modules and connections.

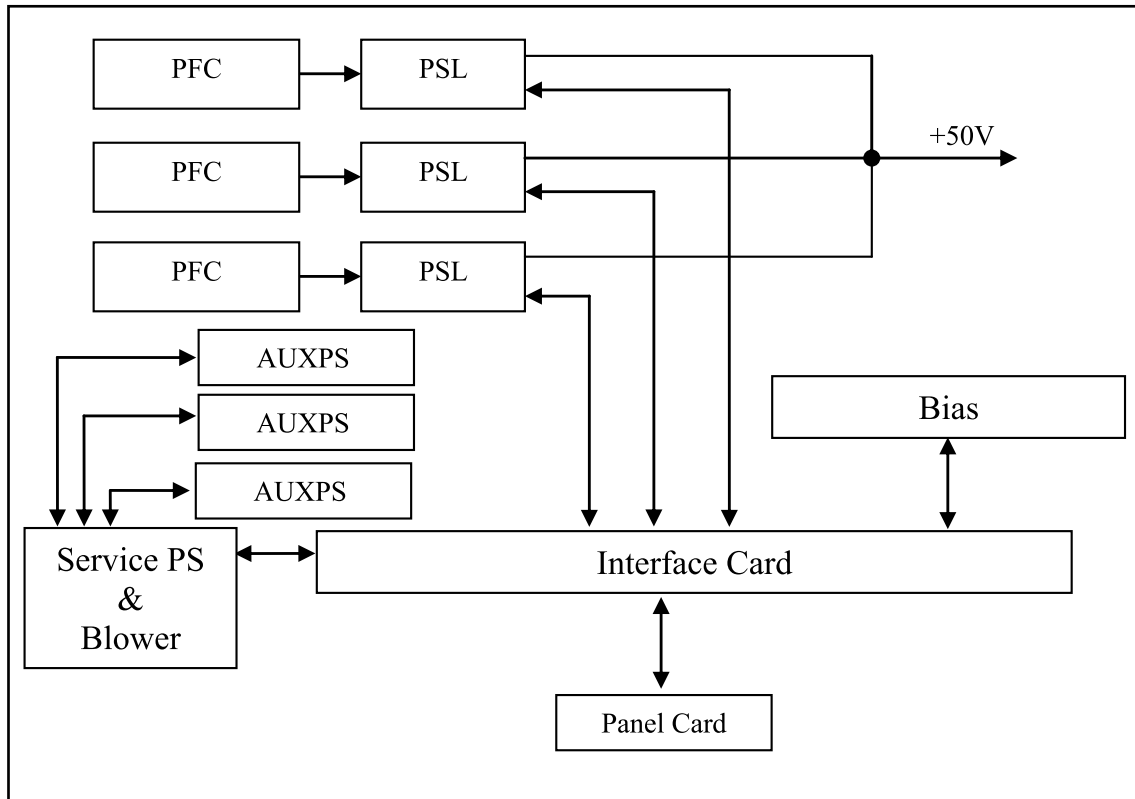

figure 7.2

7.1.1 PFC Unit

The three PFC units are rectifiers that modulates the absorbed current so that the wave shape is the most possible sinusoidal, obtaining a power factor with a $\cos \phi$ of 0.998 and can work with input supply voltages from 186 to 250 V.

The PFC units are mounted on a plate fixed to the central heat sink, in order to allow an easy replacement in case of failures.

7.1.2 Power Supplies

The three power supplies are located in the high part of the amplifier connected in series to PFC units and deliver at the output an adjustable voltage from 20-50 VDC connected in parallel by a bus sharing system.

The power supplies are mounted on a plate fixed to the central heat sink, in order to allow an easy replacement in case of failures.

7.1.3 Services Power Supplies

The services power supplies present on this amplifier, providing a DC voltage of 24 VDC and have a maximum power of 130 W each.

7.1.4 Services PS control and Blowers

This module parallelizes the DC voltage of 24 VDC coming from the services power supplies, and has a control line which allows to reduce the necessary output power in the event of a fault in one of services power supplies or in case of lack of one of supply phases, furthermore, it measures the temperature through the sensor mounted on the main heatsink; this allows the automatic adjustment of the blowers present on the machine.

7.1.5 Interface card

This card principally performs the interface function, processing and distribution of several control signals generated by the various cards present in the equipment.

7.2 RF Section

The figures below provide a schematic view of PS section of **Thesla AMP5K / AMP6K** (figure 7.3) modules and connections.

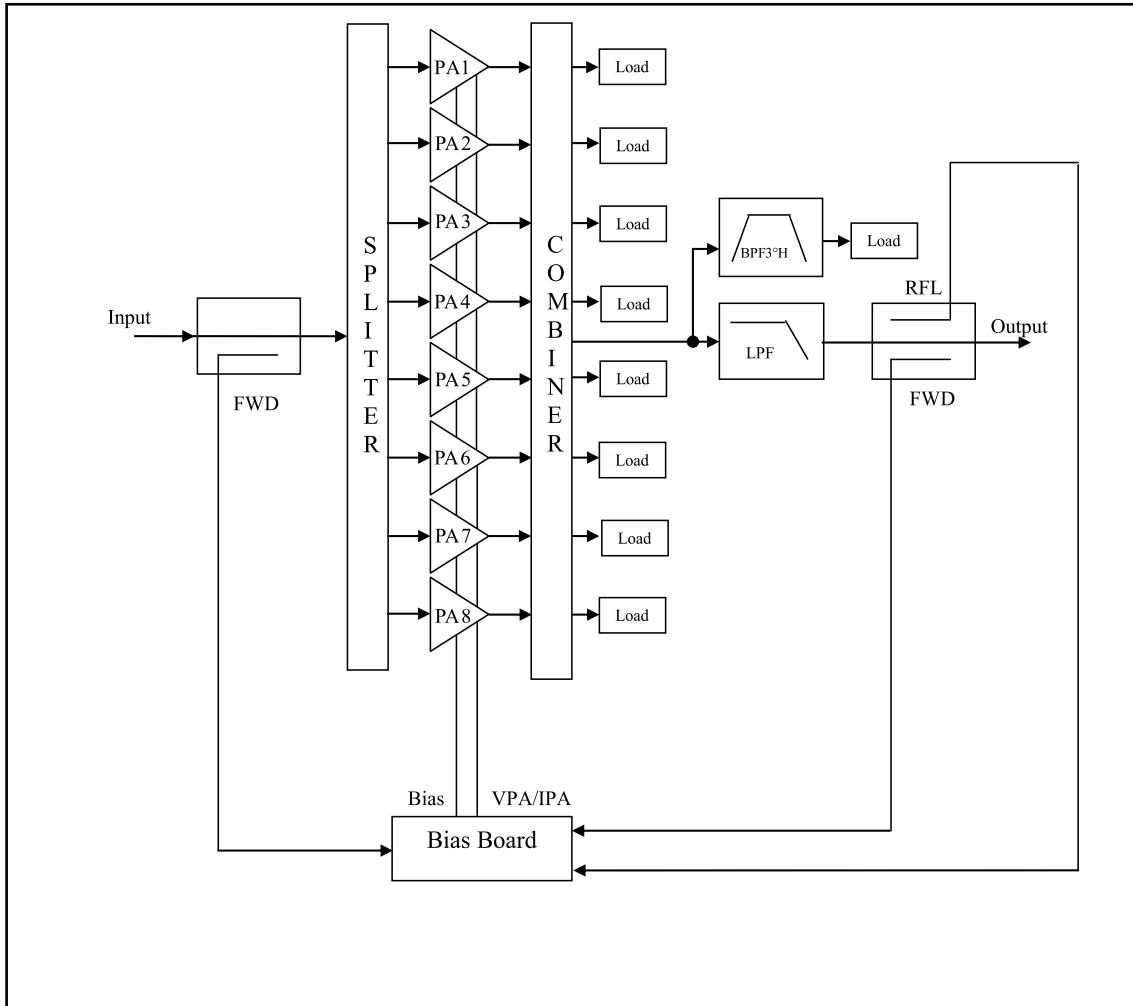

figure 7.3

7.2.1 PWR Input Measure Card

This card measures the input power and send it subsequently to the bias card, which provides to send to protection in the event of excess power.

7.2.2 RF Power Amplifier

The RF modules, the splitter and the combiner are housed inside the lower part of the equipment.

The RF amplifier section consists of 8 power modules coupled by an isochronous combiner realized with coaxial cables hat guarantees reliability and durability..

The splitter is used to divide input power from PWR Input Measure card and to supply a part of it to every RF module. The combiner is used to combine output power from every RF module so as to have total power amplifier.

Splitter, amplifier and combiner are plans so that powers generated from the amplifiers add its in phase, diminishing the loss of balance and therefore the dissipation of useful power.

All RF section is placed on a fin that supplies to the cooling through forced ventilation.

Every RF module supplies 850 watts and is supplied from own switching supply.

The active device used in the amplifier modules is a single LD Mosfet.

The task of the low-pass filter is to reduce the harmonic emissions of the amplifier to below the levels allowed by standards.

7.2.3 Bias Board

The task of this card is to measure the current drawn by the RF modules, and the several input and output power, providing for fault reporting and the management of their guards.

This card also carries the signals to the DB15 connector, located on the rear panel of the equipment, in RS485 standard for uses in multiple amplifiers systems

The card also manages the **/LD-PJ** option (LOW POWER INPUT - optional), if it were installed in the machine.

7.2.4 Directional Coupler

The task of this card is to take a part of RF signal and send it to the interface card, where it will be straightened and measured.

The directional coupler is an integral part of output connector.

7.3 Logic Section

The figures below provide a schematic view of Logic section of **Thesla AMP5K / AMP6K** (figure 7.4) modules and connections.

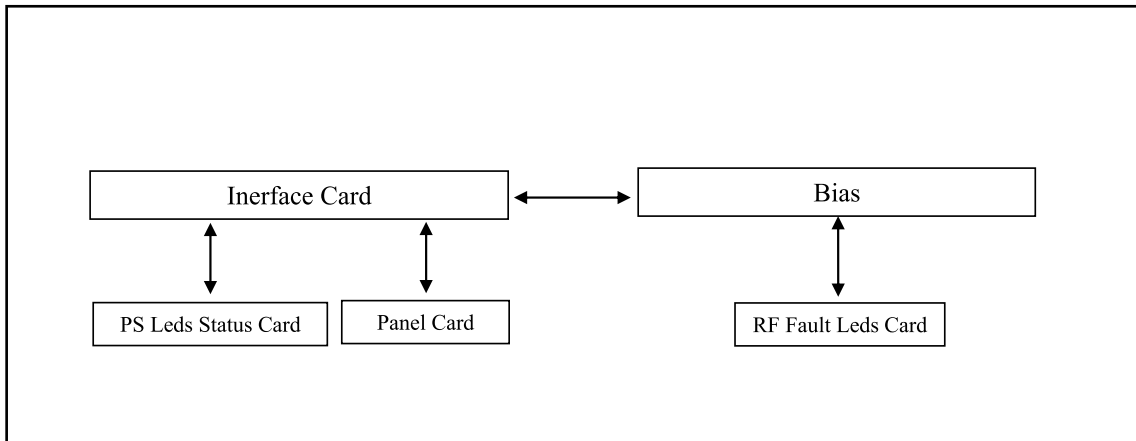

figure 7.4

7.3.1 RF status LEDs Card

This card is fitted with four warning LEDs that indicate the machine’s general operating status.

It also has a trimmer for adjusting power. Use a small screwdriver to change the delivered power.

7.3.2 PS status LEDs Card

Three LEDs are present on this board for indicating the operating status of the three power supply modules and a fourth LED indicating the status of the service supplies.

The lighting up of a LED indicates a malfunction in the associated module.

7.3.3 Panel tab

The panel board accommodates the microcontroller that runs the machine control firmware and all user interface elements (display, LED’s, keys, ...).

This board is interfaced with other machine modules via flat cables to facilitate the replacement of module in case of failures.

This card carries the signals to the DB25 telemetry connector that is on the machine's back panel. The connector is fitted with 7 analog outputs, 8 open collector digital outputs and 4 digital inputs. It also manages the DB9 connector for communications in I²C standard.

8. “Low-Drive Power” Option (/LD)

The figures below provide a schematic view of RF section of **Tesla AMP5K / AMP6K** (figure 8.1) modules and connections.



figura 8.1

8.1 “Low-Drive power” Board

The “Low-Drive power” board contains an RF amplifier with only one stage that, with a power of about 1W, can supply an output power of approximately 50W suitable to pilot the amplifier.

The active device utilized in the amplifier modules is a Mosfet and uses for the feeding the same voltage of $50V_{DC}$ used from the eight RF amplifiers modules.

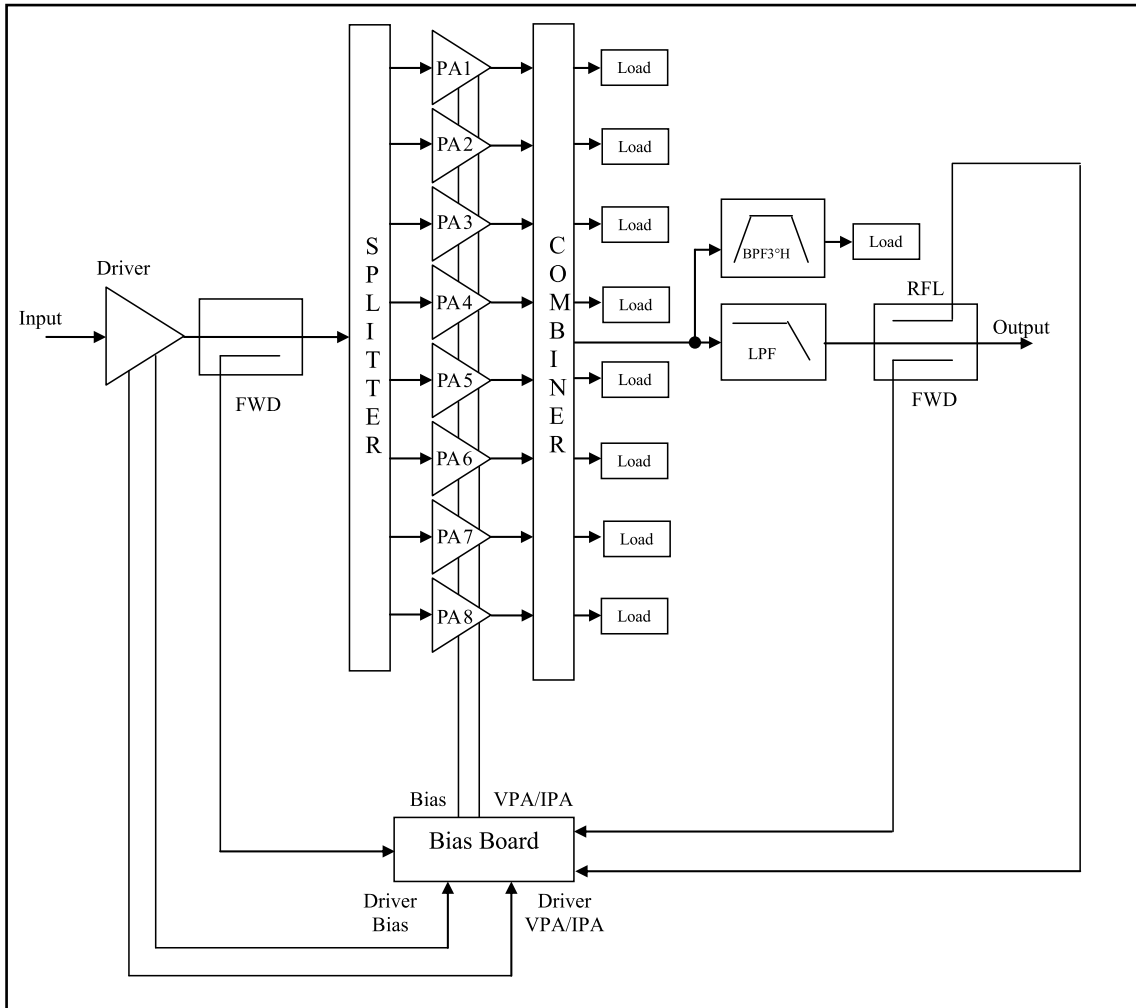
On the output stage of this board is present a directional coupler that measure the reflected and forward power; the latest comes acquired from the control software that represents it legible like input power.

The board is mounted on the fin that supplies to its cooling through forced ventilation.

9. Maintenance and repair procedures

9.1 Introduction

This section provides general information about maintenance and electrical settings for the **Thesla AMP5K / AMP6K** amplifier.

The maintenance is separated into two sections depending on the complexity of the procedure and the instrumentation required for the test to complete the maintenance.

9.2 Security Considerations

Dangerous voltages and high currents are present inside the amplifier, when it is working; strong power RF signals are present, also.



WARNING: Do not remove any covers without first turning the equipment off and making sure that you have closed them all before restarting the equipment. Be sure to disconnect the amplifier's mains supply before proceeding to any maintenance operation on the system.

9.3 Ordinary maintenance

The only regular maintenance required on the **Thesla AMP5K / AMP6K** is the periodic blower replacement and dust cleaning of the air filter and of any trace of it inside the amplifier.

The frequency of these operations depends on the operating conditions of the machine: like ambient temperature, dust level in the air, humidity, etc ...

It is advisable to make a preventive inspection every 6 months, and to replace the blowers that has abnormal noises.

The blowers should be replaced, in case of problems, as soon as possible and in any case not later than 24 months.

9.3.1 How to replace a malfunctioning blower

- Unscrew all screws **A** on the front panel of **Thesla AMP5K / AMP6K**

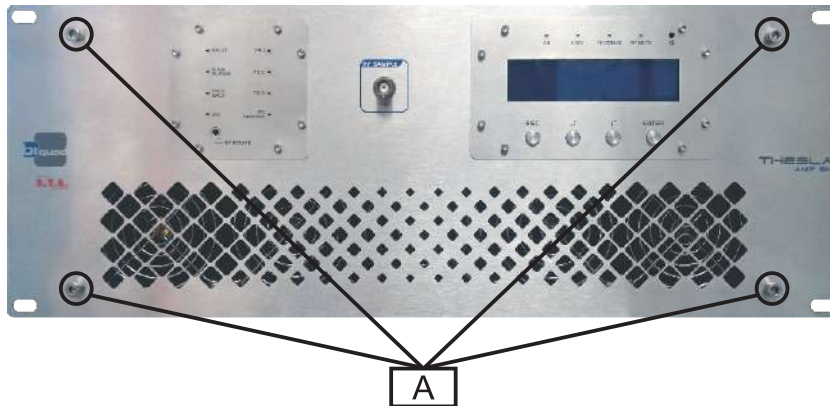

- Disconnect the power fan connector **B**, unscrewing the two slotted screws present.

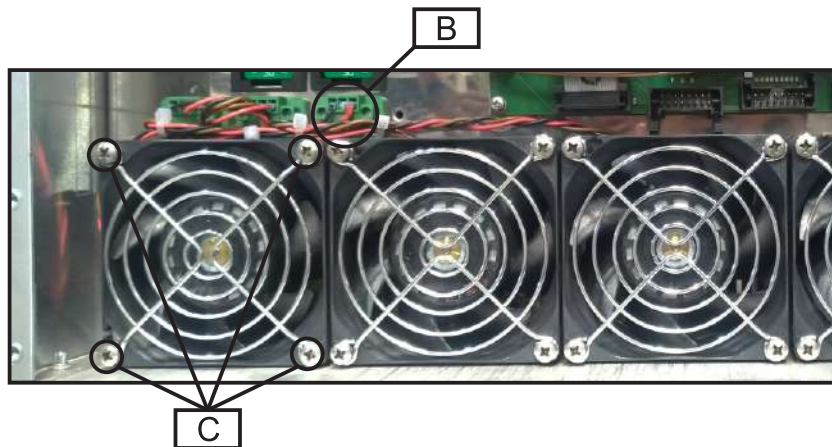

- Unscrew the four screws **C** and remove the malfunctioning blower.
- Insert the new blower (mod. **9GV0824P1G03 Sanyo-Denki**) and retighten the four fixing screws **C**.
- Reconnect the connector in the position **B** and secure it with two screws.
- Replace the front cover and screw all the screws into the position **A**.

9.4 Module substitutions

Only authorized and qualified technical personnel must be proceed with the replacement of the component parts in the relevant device.

9.4.1 How to replace the RF module

- Open the bottom cover of **Thesla AMP5K / AMP6K** by unscrewing all the screws.
- Identify the RF module to be replaced by a visual inspection, a check on the voltage and/or the verification of a possible broken fuse.

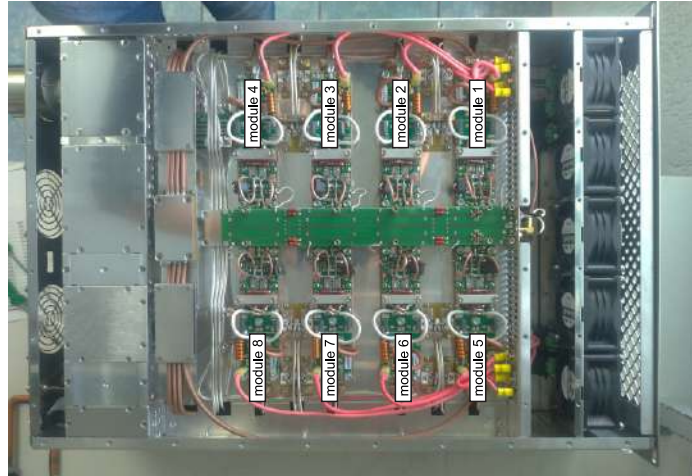

- Disconnect connector **A** and unsolder points **B**.

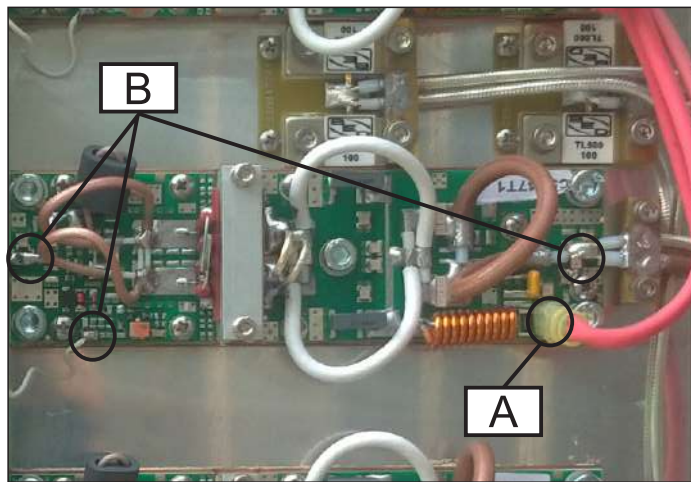

- Unscrew all the Allen screws located in positions **C**.

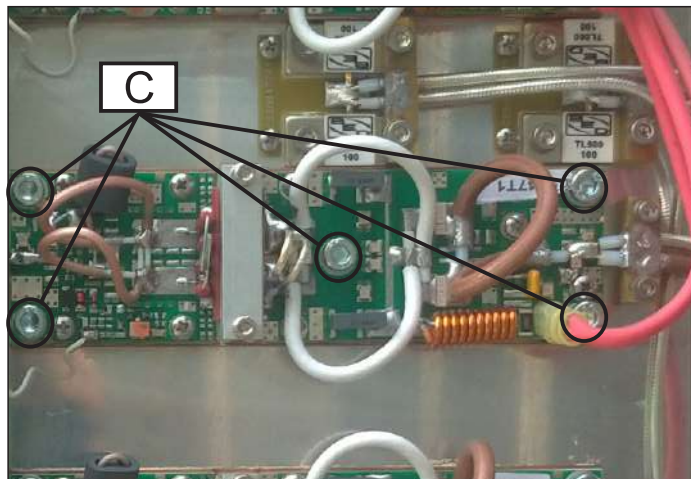

- At this point, replace the module, placing on the back of the new RF module some Compound paste with high thermal conductivity and without silicones. We recommend the Compound paste of the HTC Electrolube, or equivalent.

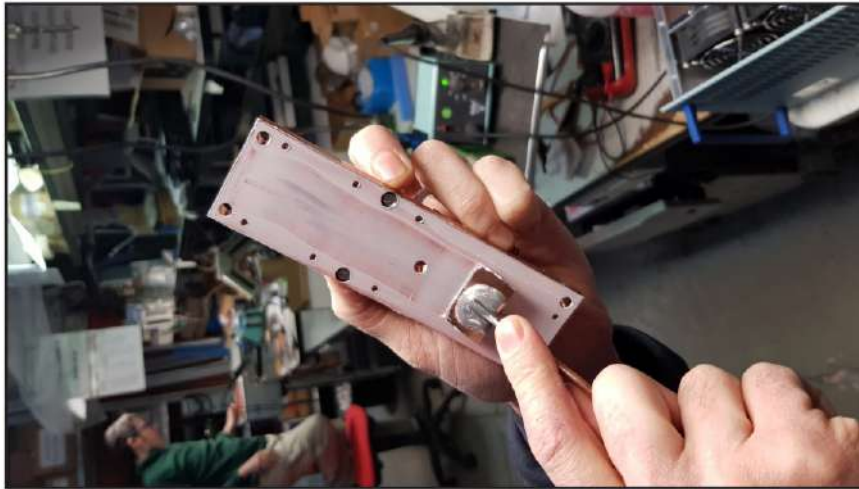

- Replace the RF module in its housing and resolder the points **B** points.
- Place an amperometer in series to 50VDC (see points **D**). Verify, with the equipment switched on but without power input, that there are 1A otherwise intervene on the trimmer **E** until to the reading of the indicated value. However, if the amperometer does not provide any indication, it is very probably that the fuse is broken.

Proceed with its replacement by following the next chapter.

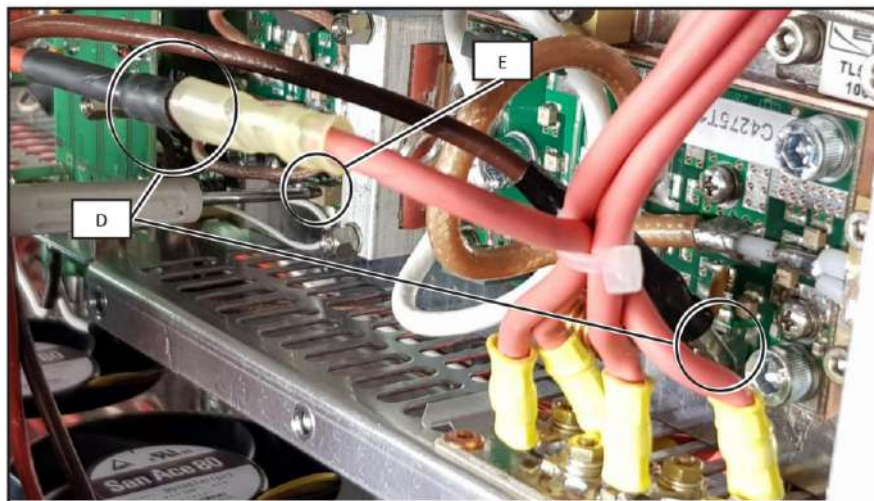

- At this point, screw the screws into the position **C**.
- Reconnect the connector in its housing **A**.
- Put the cover back on and tighten all the screws necessary to close it.

9.4.2 How to replace the fuses

- Unscrew all screws **A** on the front panel of **Tesla AMP5K / AMP6K**.

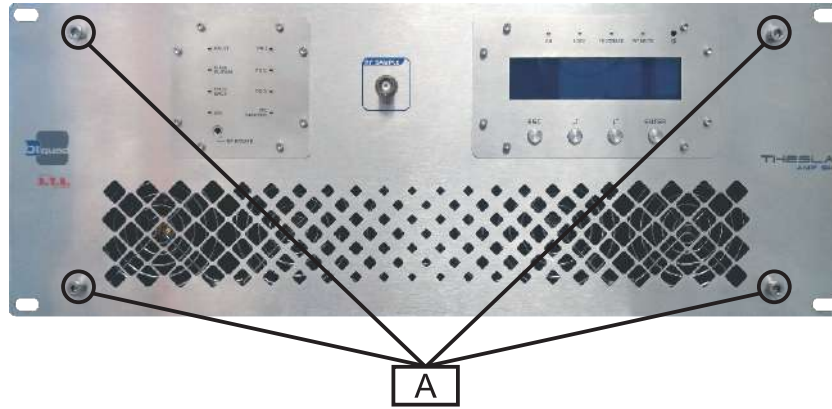

- Identify the broken fuse.

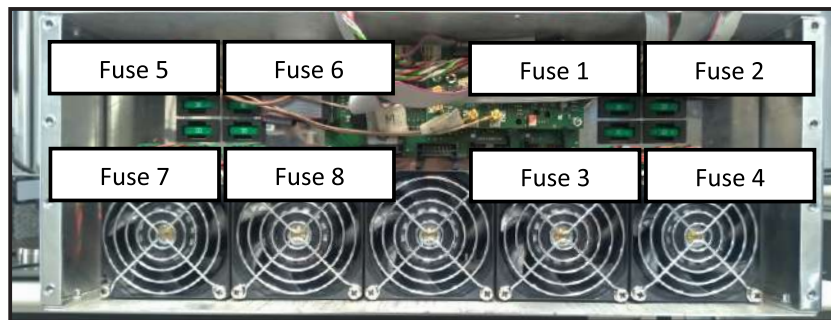

- Replace the broken fuse, with one of equal value, as in point **B**.

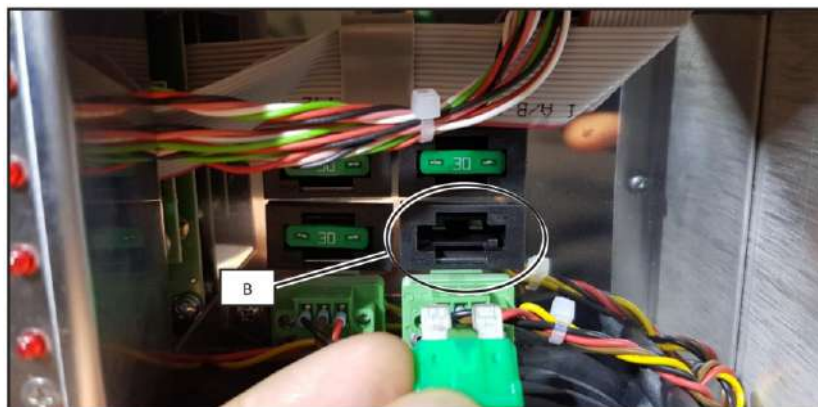

- Redo all previously steps, performed in reverse, in order to reassemble everything.

9.4.3 How to replace the power supply

- Open the top cover of **Tesla AMP5K / AMP6K** by unscrewing all the screws.
- Identify the power supply module to be replaced based on the signaling LED on the front panel.

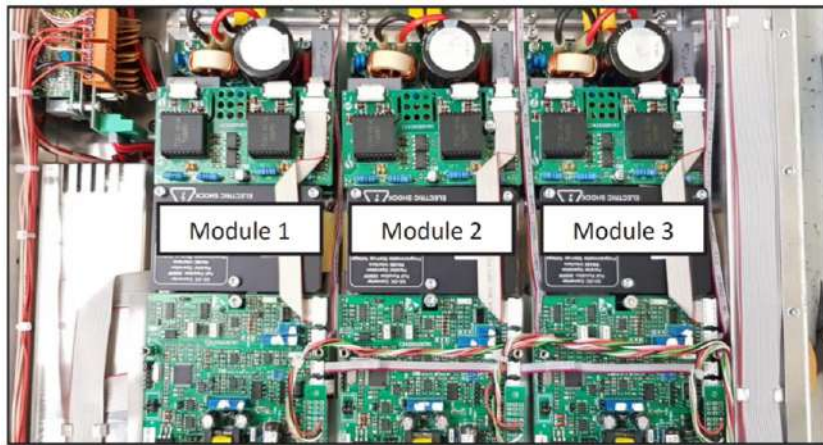

- Unscrew all the points **A** with the help of an Allen screwdriver.

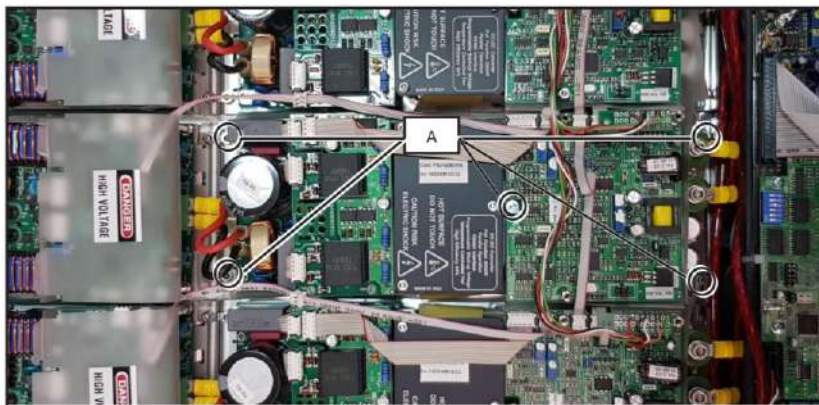

- Remove the two plates near points **A**.

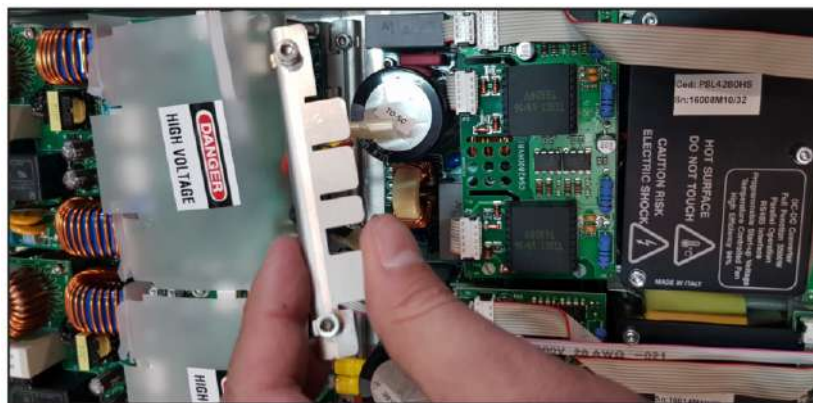

- Disconnect all the connectors at positions **B** and unscrew all the points **C** with the help of an Allen screwdriver.



- Remove the power supply module and replace it with a new spare part.

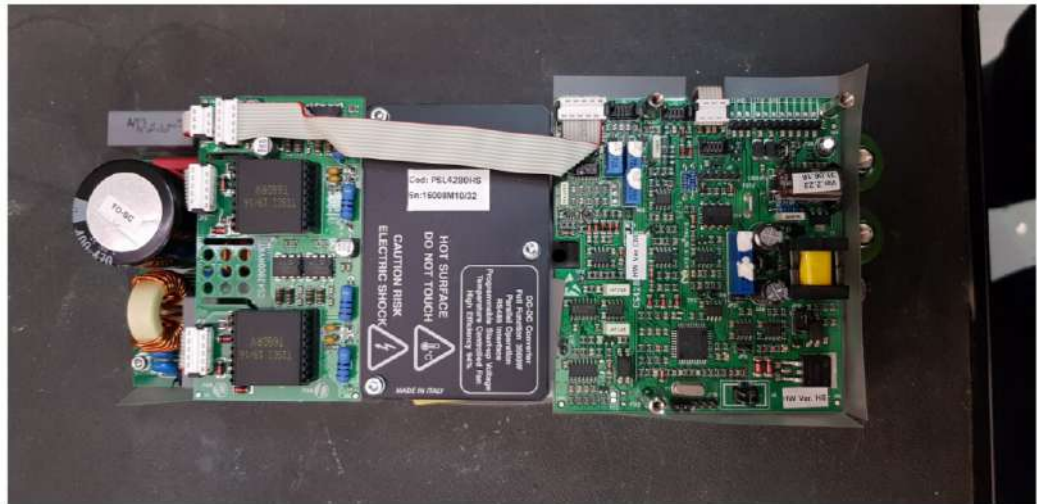

- Redo all previously steps, performed in reverse, in order to reassemble and fix the module in place.

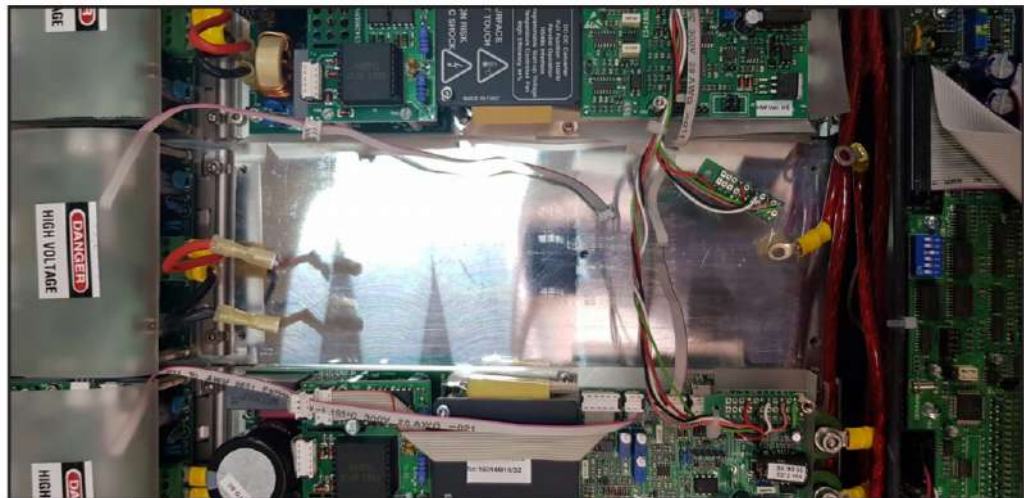

9.4.4 How to replace the PFC

- Open the top cover of **Tesla AMP5K / AMP6K** by unscrewing all the screws.
- Identify the module to be replaced.
- Unscrew all the points **A** with the help of an Allen screwdriver.

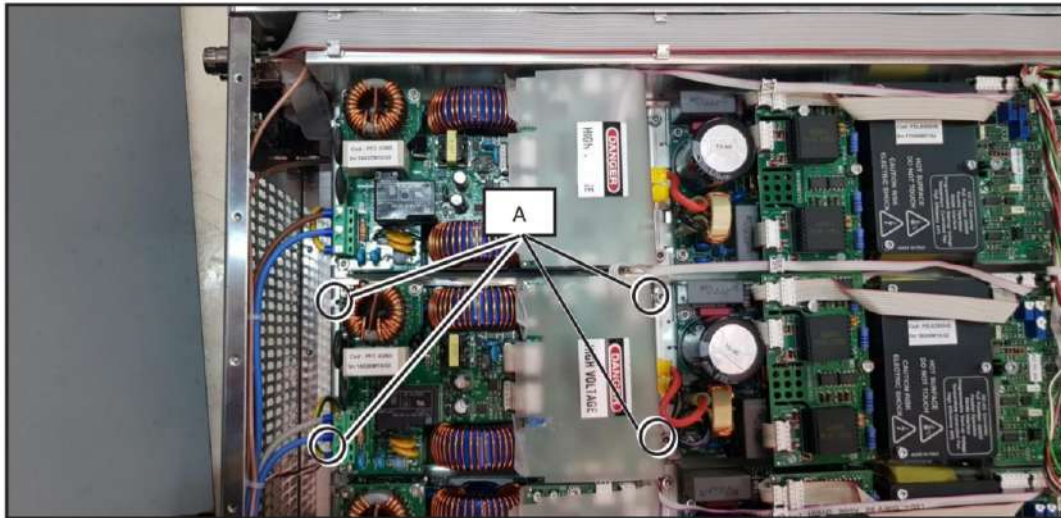

- Remove the two plates near points **A**

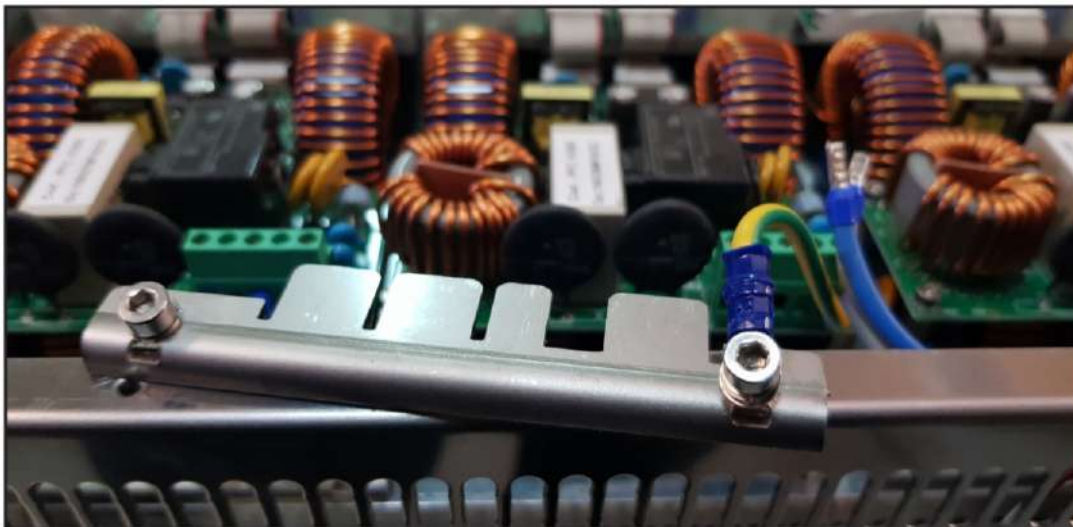

- Disconnect all the connectors at positions **B** and unscrew all the points **C** with the help of an slotted screwdriver.

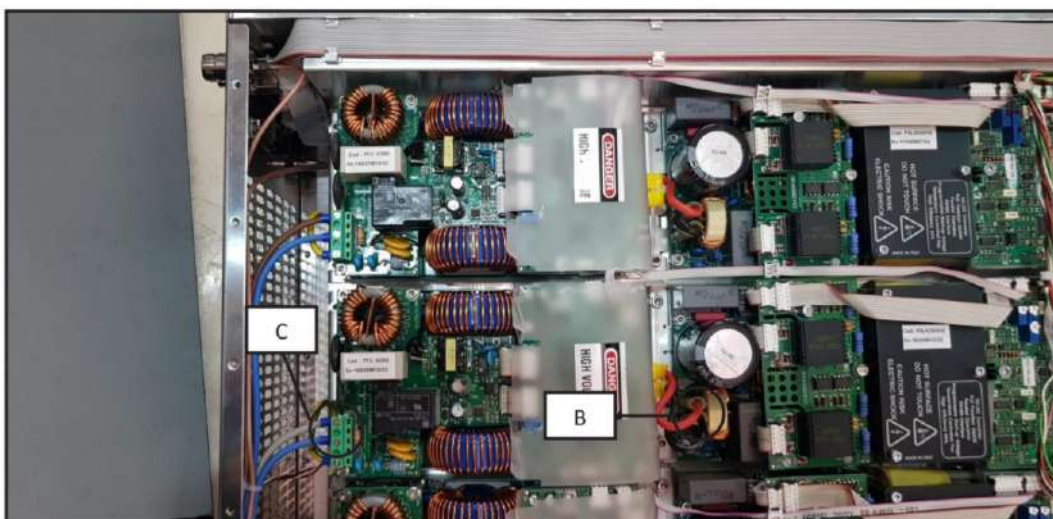

- Lift up the protective film and disconnect the connector in position **D**.



- Remove the amplifier module and replace it with a new spare part.



- Redo all previously steps, performed in reverse, in order to reassemble and fix the module in place.

9.4.5 How to replace the Service power supply

- Open the top cover of **Tesla AMP5K / AMP6K** by unscrewing all the screws.
- Unscrew all the points **A** with the help of an Quadrex screwdriver.

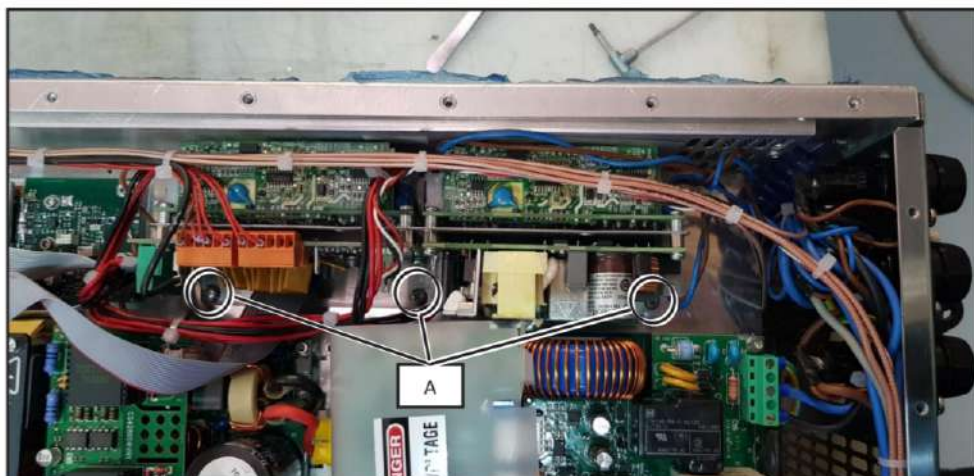

- Slip off the block of cards, by rotating it at the same time about 90°-180°.
- Identify the module to be replaced.
- Disconnect all the connectors at positions **B**.



- Unscrew all the points **C** with the help of an Quadrex screwdriver.

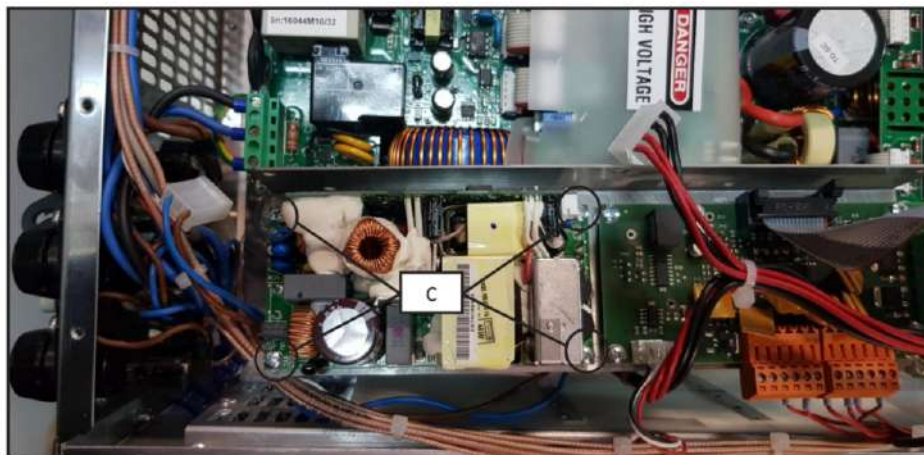

- Remove the amplifier module and replace it with a new spare part.



- Redo all previously steps, performed in reverse, in order to reassemble and fix the module in place.

This page was intentionally left blank



BIQUAD TECNOLOGIA LTDA.
Rua Marcos Flávio e Dias, 260 - Fernandes,
Santa Rita do Sapucaí / MG - Brazil CEP: 37540-000
Telephone: +55 35 3471-6399
Email: sales@biquadbroadcast.com
Web: www.biquadbroadcast.com

The BIQUAD Logo, and others referenced BIQUAD products and services are trademarks of Biquad Tecnologia Ltda. BIQUAD ® all rights reserved.

All other trademarks, trade names or logos used are property of their respective owners.